



Enhancing VoIP with Voice Peering

Presented by:

Shrihari Pandit, President & CEO

Stealth Communications

<http://www.stealth.net>

+1-212-232-2020

Background

- **Current Model: The Public Telephone Network**

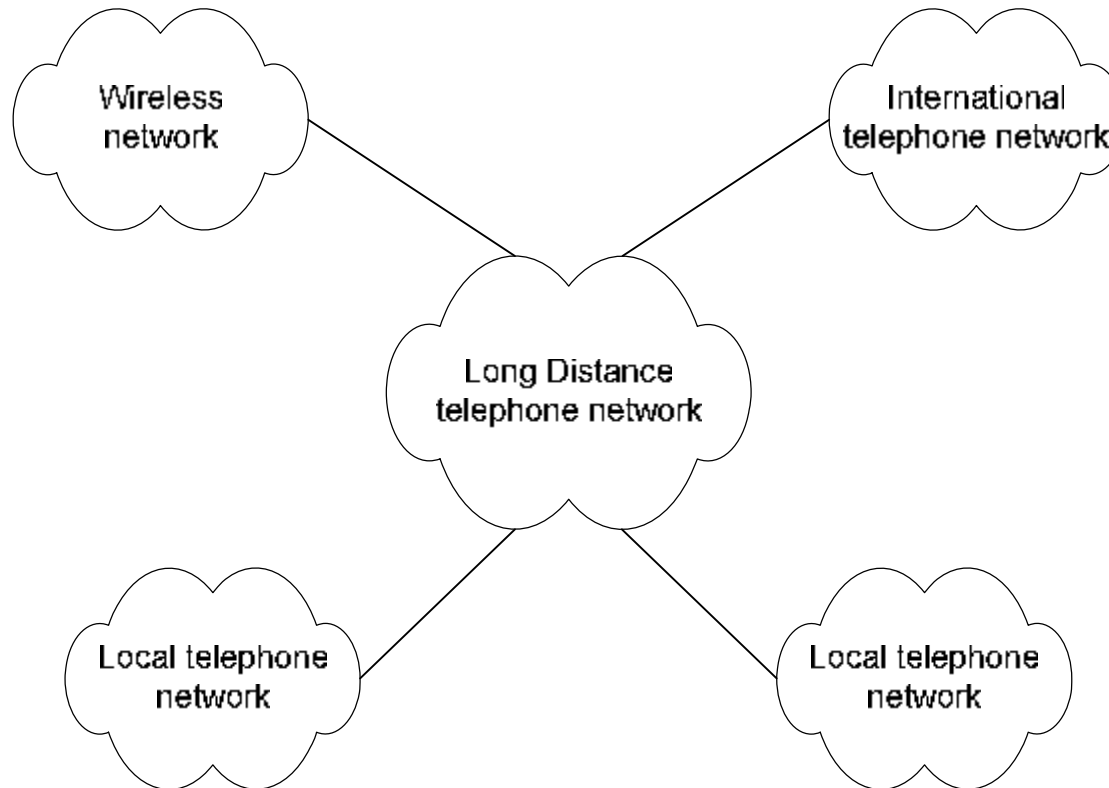

Background

- **Current Model: The Public Telephone Network**

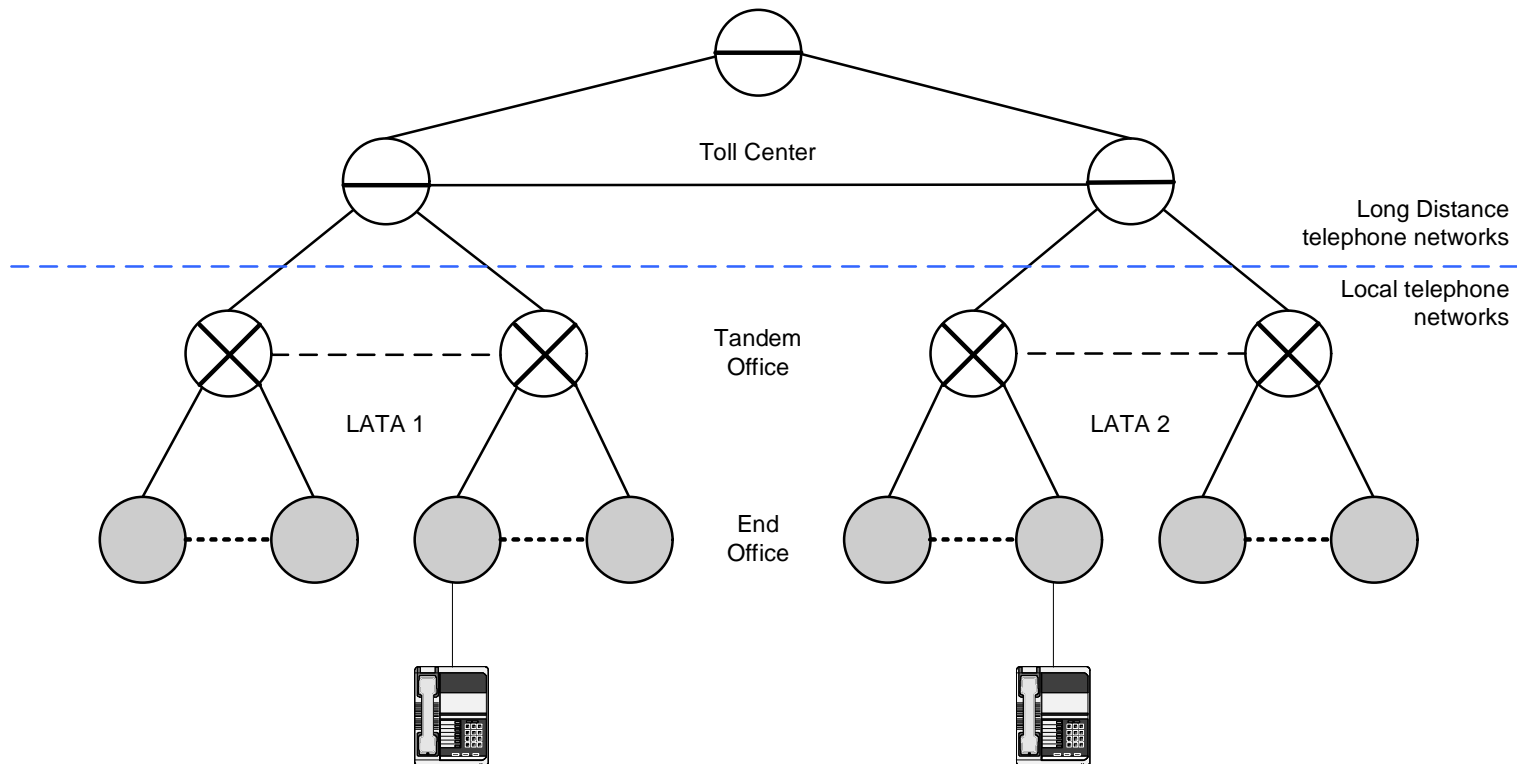

Background

- Current Model: The Public Telephone Network

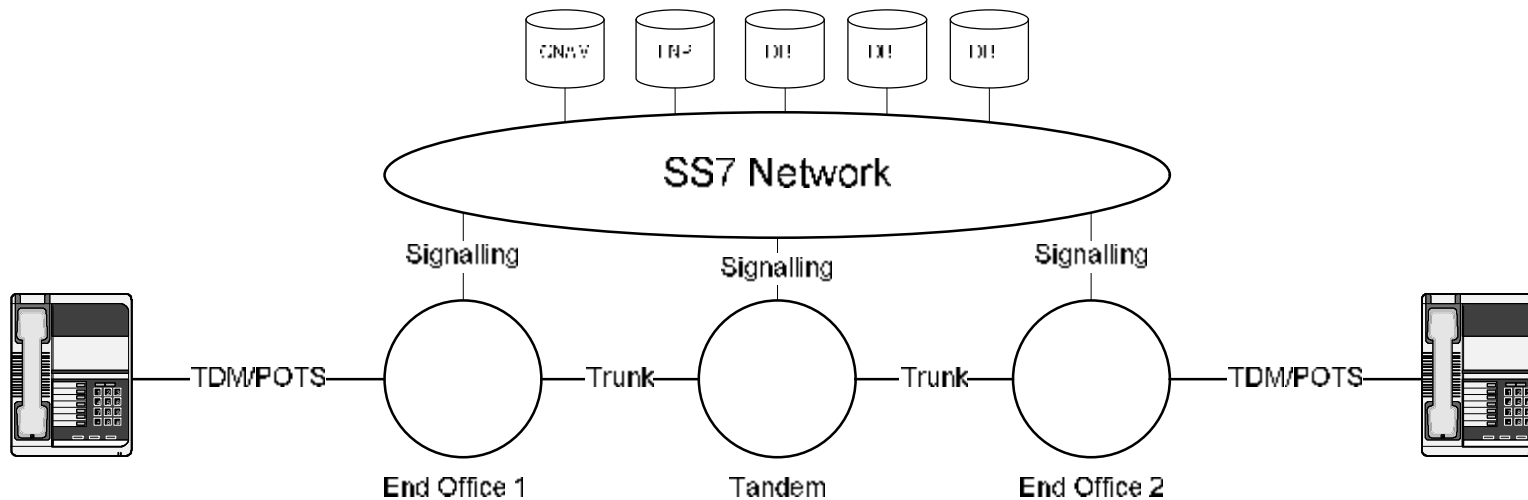

Background

- **Current Model: Passing traffic via the PSTN**

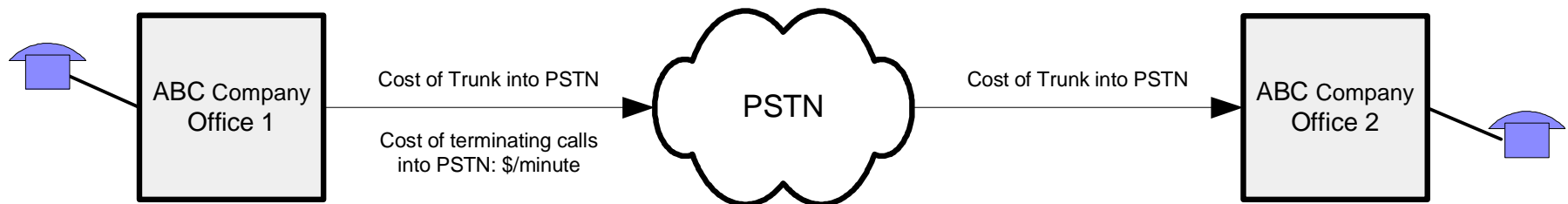

- 1) Cost of TDM Trunk(s) (circuit) into PSTN;
- 2) Cost per minute to terminate to remote location(s)



VoIP Growth

VoIP Equipment Market: Total Market Revenue Forecast (World)
Source: Frost & Sullivan

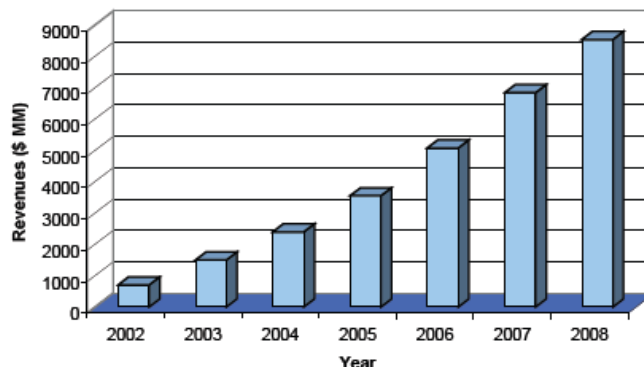

VPF Traffic Statistics & Forecast

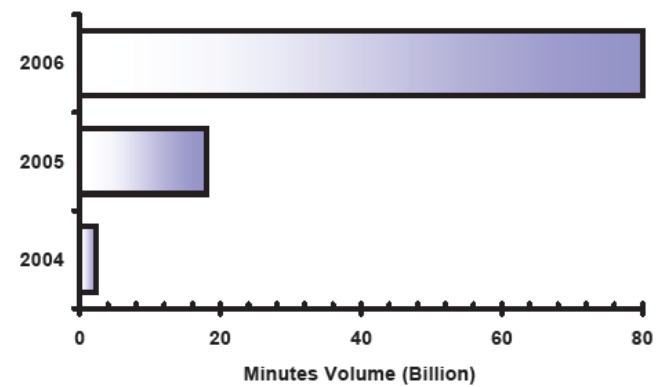

VoIP Subscribers by Service Provider, Q1 2003 - Q4 2005

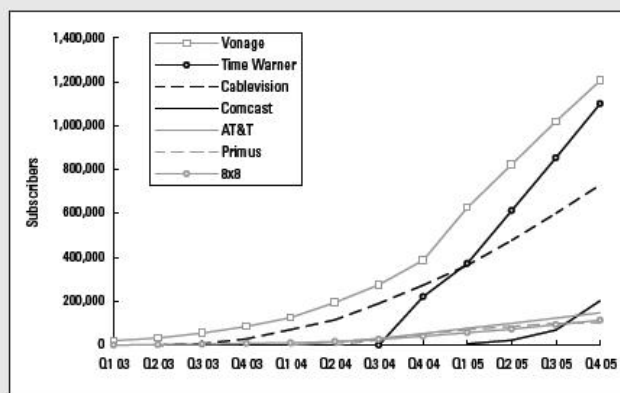

Source: TeleGeography research

© PriMetrica, Inc. 2006

VoIP Subscribers by Provider Type, Q1 2003 - Q4 2005

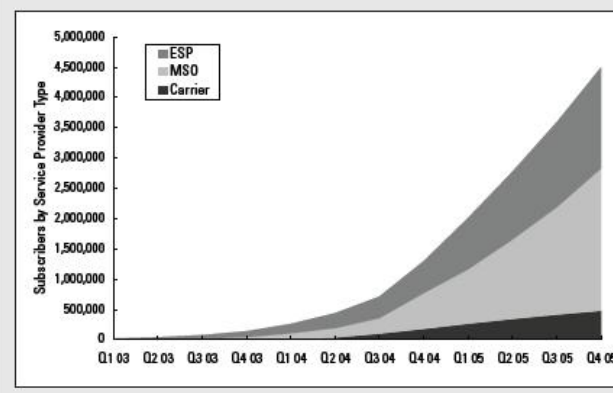

Notes: Carriers include ILECs, CLECs and IXCs.
Source: TeleGeography research

© PriMetrica, Inc. 2008



What is Voice Peering?

- Interconnection of telephony networks
- Bilateral Peering/Relationships (Settlements)
- Multi-lateral Peering (Settlement-Free)

Public

via Internet

Best-Efforts

Home-users (PC-to-PC)

Private

via dedicated connections

Security & Quality Controlled

Enterprise / Carriers



Voice Peering Methods

- **Static Routing (Least Cost Routing, "LCR")**

Country/City Prefix	Trunk Group (TDM or IP)	Notes
+ 44	Trunk Group #0 TDM	UK - United Kingdom
+852	Trunk Group #1 192.168.1.100	HK - Hong Kong, China

- **ENUM (IETF standard)** – Mapping of Telephone Numbers to Internet Addresses

E.164 Phone Number	Protocol	URI
+12122322020	SIP	sip://100@sys1.ny1.stealth.net
+12125551212	H.323	h323://1212@company.com

- **SRV (IETF standard)** – Mapping of domain names to Internet Addresses



Voice Peering Issues

- **Connection Method**
 - How to interconnect with networks efficiently,
 - With security with quality of service
- **Software & Hardware**
 - Keeping existing investments
 - Utilize Media Gateways, SIP Proxy Servers...
 - Voice Peering Technology: SIP, ENUM, SRV, LCR
 - [Savings up to 50-90% by Voice Peering](#)

Voice Peering Implementations

- A corporate voice WAN to perform toll bypass:

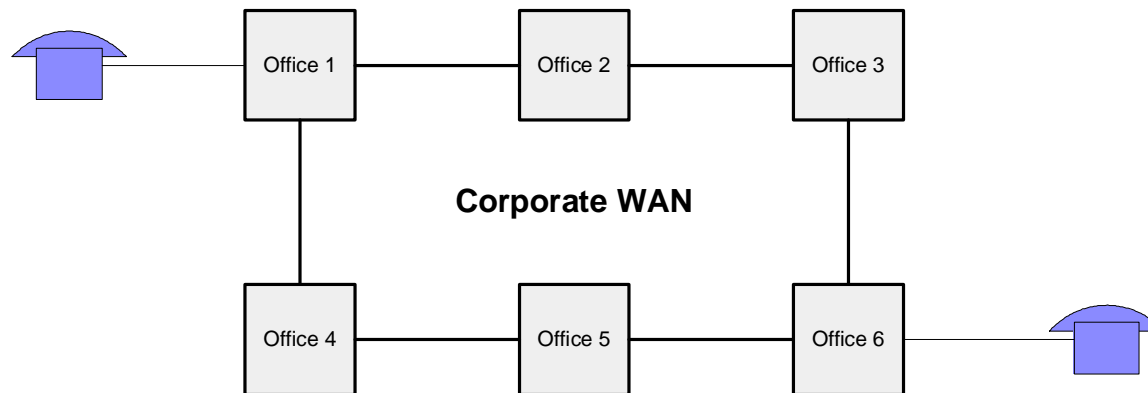

ABC Company has X month ROI based on toll savings.

Voice Peering Implementations

- Toll bypass between two companies

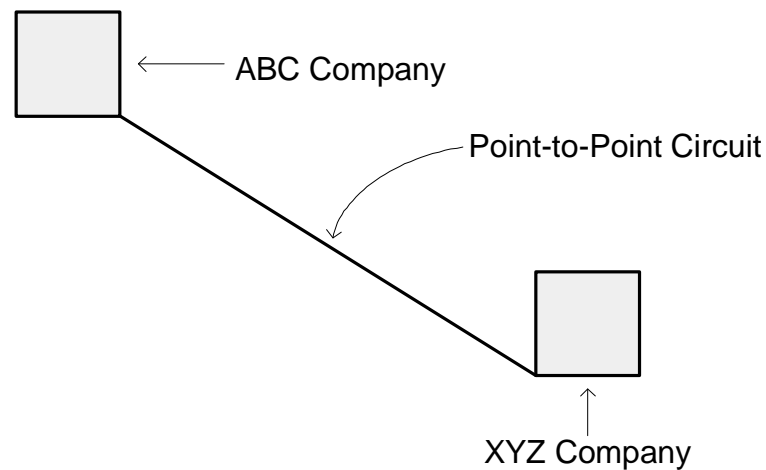

ABC Company reduces monthly call spending to XYZ Company.

Bilateral Peering

Voice Peering Implementations

- Toll bypass between many companies across a common WAN (e.g. public Internet):

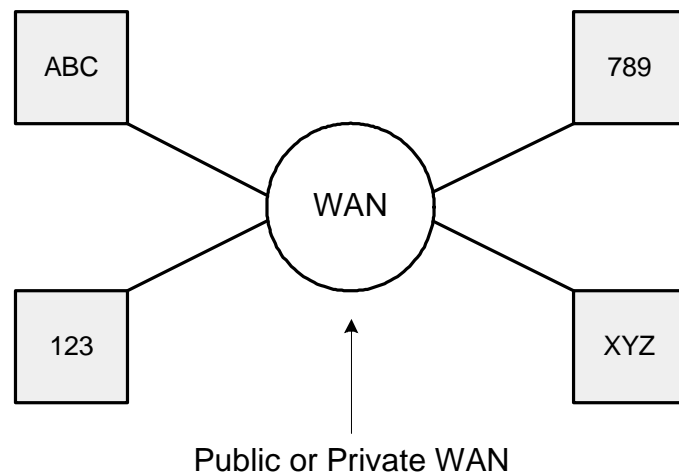

- ∅ Each company establishes connection into the WAN;
- ∅ Each company maps telephone numbers to one another (LCR, ENUM, SRV, etc.)
- ∅ Toll free calling between any company in this community.

Multi-lateral Peering



Introducing the VPF

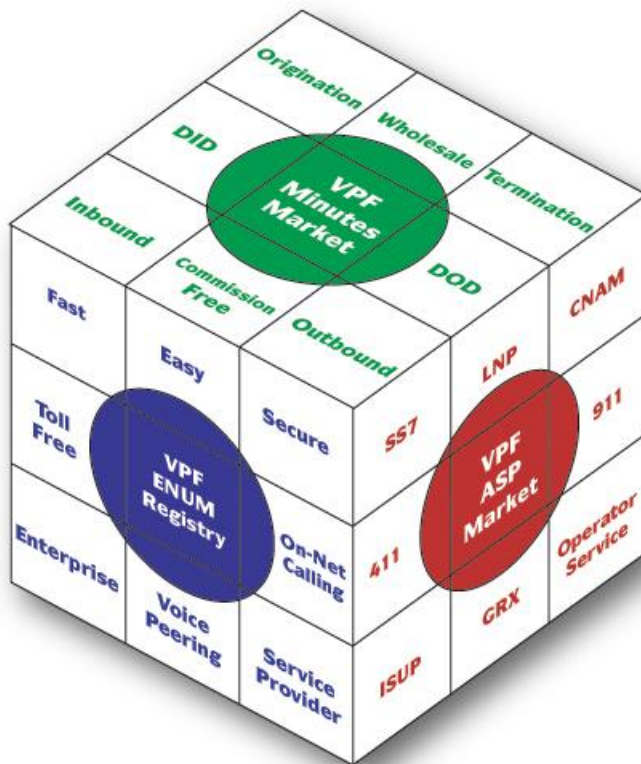

A Private Voice Internet

- ∅ The VPF Minutes Market
- ∅ The VPF ASP Market
- ∅ The VPF ENUM Registry
- ∅ The VPF SRV Registry



VPF Locations

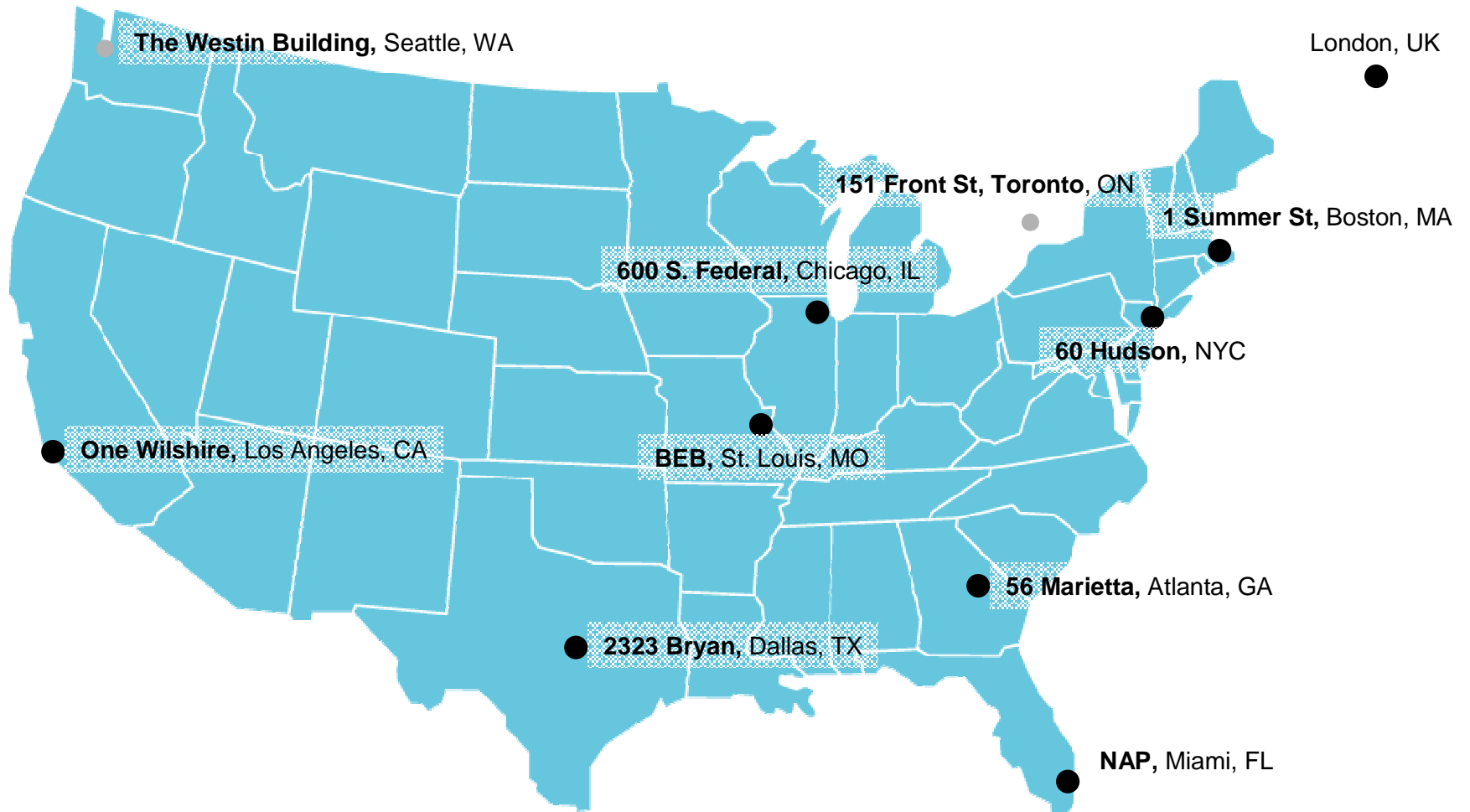

Last Updated: Jul 26 2006

© 2003-2006 Stealth Communications, Inc.
Proprietary and Confidential; do not copy, duplicate or distribute

<http://www.thevpf.com>



VPF Minutes Market

- Ø Direct access to multiple carriers and enterprises
- Ø Buy & sell origination (DID) and termination (DOD) services
- Ø The freedom to negotiate direct bilateral relationships
- Ø Your choice of industry standard VoIP protocols and codec's
- Ø Customize your LCR

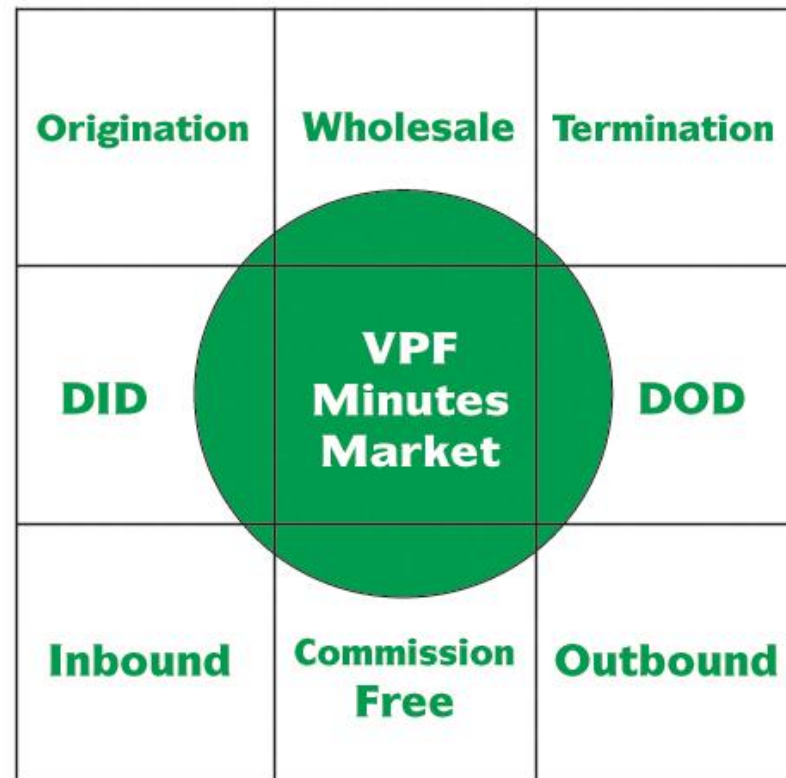

VPF Minutes Market

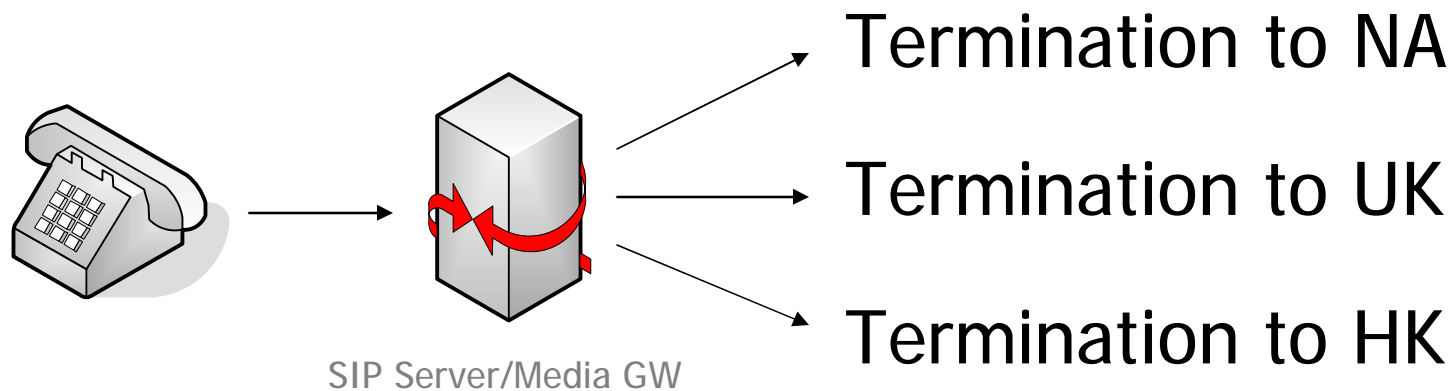

Method: Least-Cost-Routing (“LCR”)

Country/City Prefix	Trunk Group (SIP/H323)	Notes
+ 1	Trunk Group #0 192.168.1.101	North America (NA)
+ 44	Trunk Group #1 192.168.1.102	United Kingdom (UK)
+852	Trunk Group #2 192.168.1.103	Hong Kong, China (HK)

VPF ASP Market

Access critical database and gateway services via the VPF

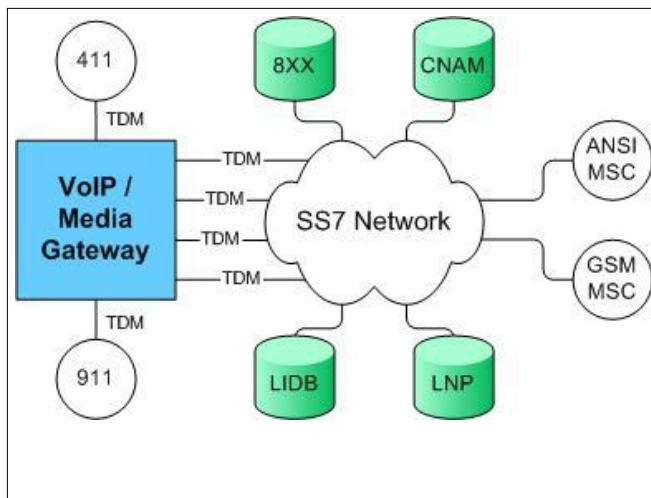

... and avoid the cost and complexity of SS7 / TDM technology.

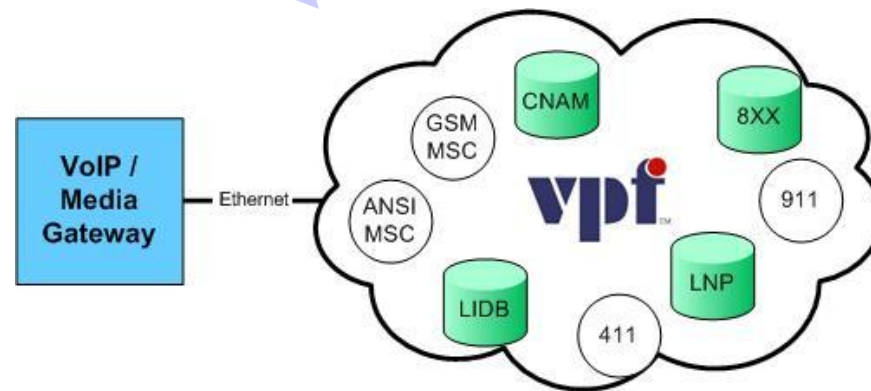

VPF ENUM Registry

Fast, Easy and Secure.

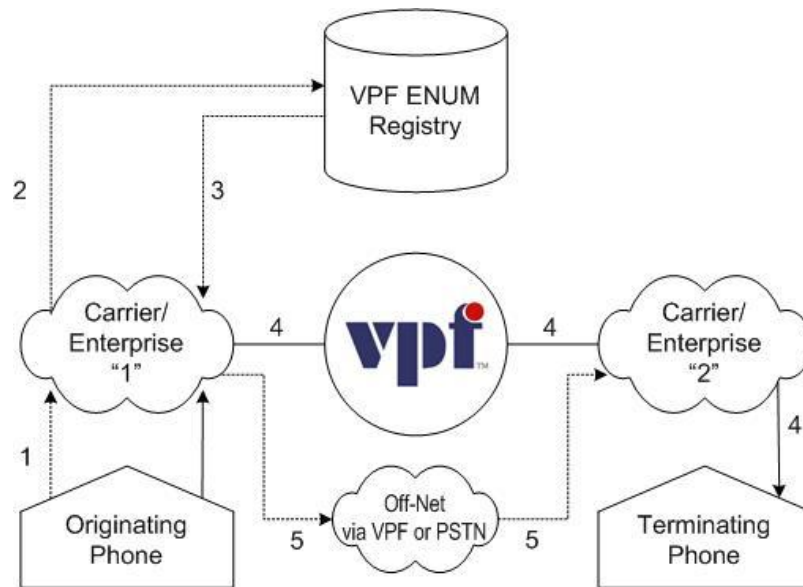

- Ø Multilateral peering:
Send and receive calls for *free* with other members
- Ø Calls remain within the IP domain and completely bypass the PSTN
- Ø No transaction fees
- Ø **Toll bypass at it's best!**

VPF SRV Registry

Fast, Easy and Secure.

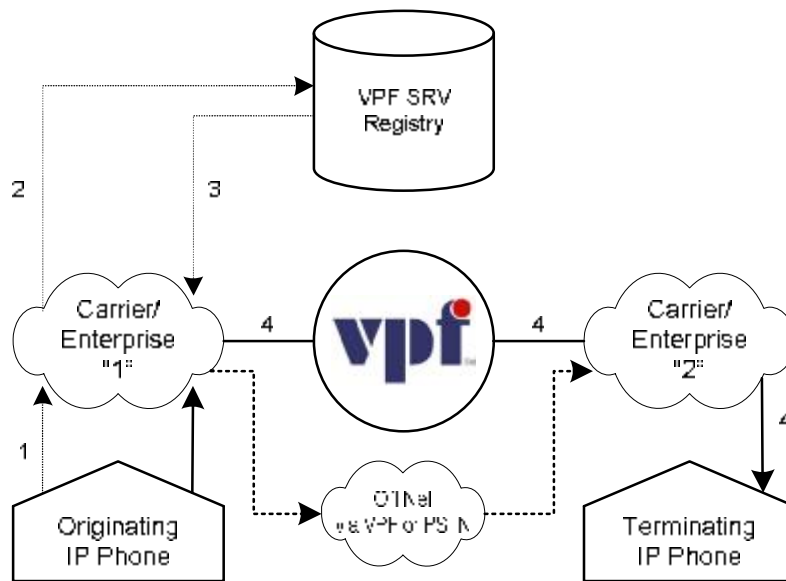

- Ø Multilateral peering:
Send and receive calls for *free* with other members
- Ø Calls remain within the IP domain and completely bypass the PSTN
- Ø No transaction fees
- Ø **Toll bypass at it's best!**



Real Life Implementation

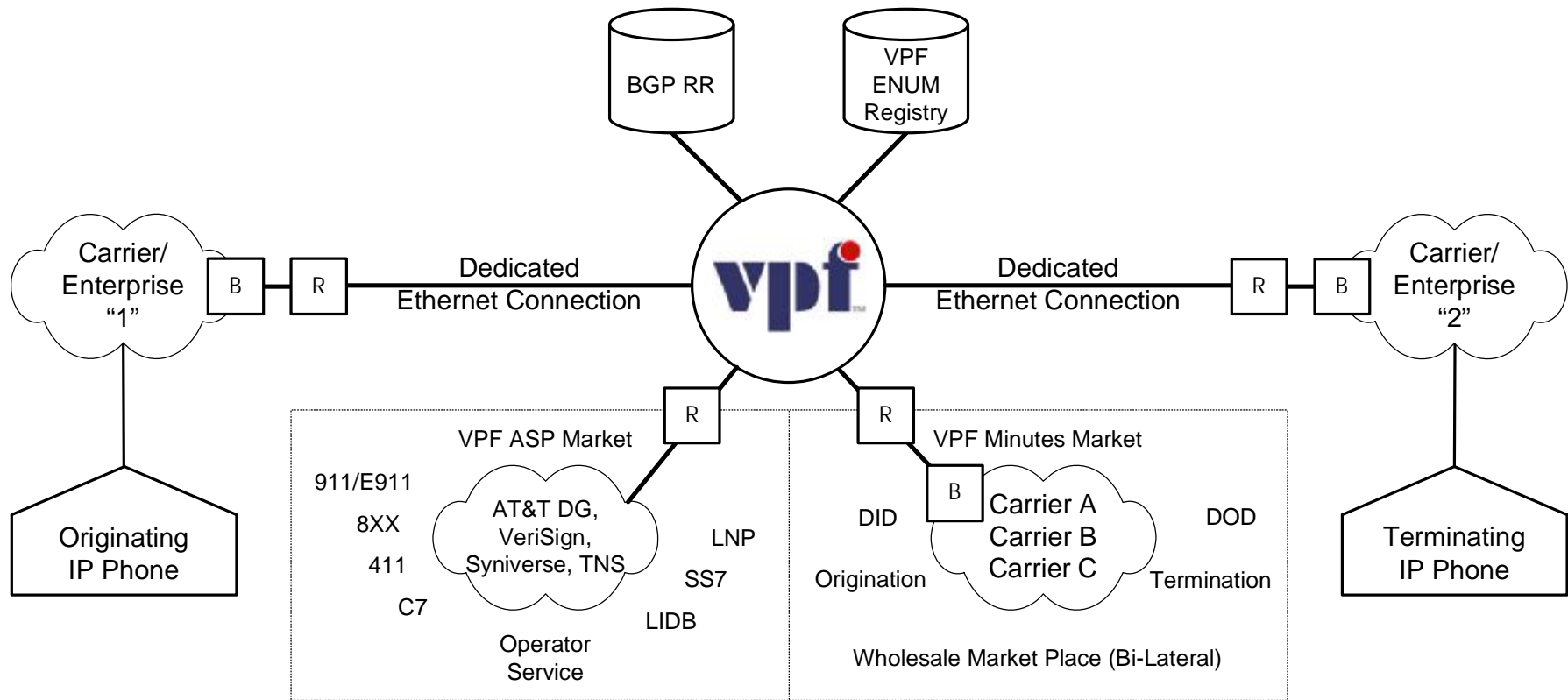



Real Life Implementation

- **Benefits Include:**

- * **Security**

- The Voice Peering Fabric is a private Internet

- * **Quality**

- dedicated to the exchange of voice and telephony services

- * **Simplicity**

- via a distributed Layer-2 Ethernet network

- * **Choice**

- with a wide range of DID/DOD options and rate structures

- * **Savings**

- enables a competitive environment in this open marketplace



State of Voice Peering

- VPF Members Include:

- AT&T Wholesale
- 3U Telecom
- Aurora Cable TV
- China Telecom
- iBasis
- IDT Corporation
- Net2Phone
- PAETEC Communications
- RCN Corporation
- SunRocket
- Telecom New Zealand
- VeriSign
- XO Communications

Growth of the VPF >>

18 Billion and Counting ...





A Voice Peering Community

- **Voice Peering Forum & Voice Peering Workshop**
 - Hear the latest organizations who are implementing Voice Peering
 - How Voice Peering is incorporated in their network
 - Why and how they benefit
 - Buyers and Sellers Meet Face-to-Face
 - Participants share knowledge of Voice Peering technologies and Techniques
 - Learn about the latest business trends and issues of Voice Peering

*Thank
you*

For more information, visit: www.thevpf.com