

# 2N - VoiceBlue Lite

## User Manual



Version: 2.6

*Dear customer,*

let us congratulate you on having purchased the 2N – VoiceBlue Lite system. This new product has been developed and produced in order to provide the maximum utility value, quality and reliability to the user. We hope you will be fully satisfied with our 2N – VoiceBlue Lite.



The manufacturer constantly improves the software contained in the product (the so-called firmware). The technology used therein helps you download the latest firmware version to the 2N – VoiceBlue Lite VoIP GSM gateway using a common PC anytime. For the latest firmware version see [www.2n.cz](http://www.2n.cz). For necessary instructions refer to Section 7.2 hereof. We recommend you to apply the latest version to avoid problems that have already been eliminated.

Grey marked text of this User Guide specifies functions of VoiceBlue Lite, which will be supported in newer versions of firmware. You also find the latest version of the User Manual at [www.2n.cz](http://www.2n.cz).

Check your delivery for completeness according to the packing list and study this manual carefully before installing this product. The manufacturer shall not be responsible for damage caused by any use of this product in contradiction with the User Manual. The warranty terms and conditions do not apply to damage incurred as a result of gross handling and/or undue storing of the product or violation of the technical parameters included herein.

This manual is very much detailed and includes subsections that are irrelevant for the basic installation purposes as well as subsections referring to other VoIP GSM gateway models.

## ■ Packing List

---

Please check your 2N<sup>®</sup> - VoiceBlue Lite delivery for compliance with the following packing list.

Item	Pieces
2N - VoiceBlue Lite – check the model type according to the order number, see the type label on the gateway back side	1
Mains adapter according to type	1
Serial laplink cable	1
Ethernet cable (4-wire)	1
USB cable A – B	1
Antenna with a SMA connector	1
Wall mounting holder	1
Dowels	2
Screws	2
Warranty certificate	1
Compliance certificate	1
2N product CD	1



# ■ Contents

---

<b>SECTION 1 – PRODUCT PRESENTATION.....</b>	<b>3</b>
1.1. Purpose.....	4
1.2. How to Cut Telephone Costs .....	4
1.3. Other Advantages and Applications .....	5
1.4. RF Radiation Safety Precautions .....	6
<b>SECTION 2 – INSTALLATION .....</b>	<b>7</b>
2.1. Get Started .....	8
2.2. Brief Installation Guide .....	9
2.3. Proper Mounting .....	11
2.4. PC or LAN Connection.....	12
2.5. Antenna Connection .....	15
2.6. Gateway Power Supply.....	15
2.7. SIM Card Installation/Removal .....	16
2.8. PIN Entering Disable (Optional) .....	17
2.9. Status Indicators.....	17
<i>Power</i> Indicator.....	18
<i>GSM</i> Indicators.....	18
2.10. Lithium Battery Replacement.....	20
2.11. Fuse Replacement.....	22
2.12. Antenna Splitter .....	22
<b>SECTION 3 – 2N - VOICEBLUE LITE INSTALLATION .....</b>	<b>24</b>
3.1. Proper Installation Conditions .....	25
3.2. VoiceBlue Lite Installation.....	25
3.3. Potential GSM Network Problems .....	26
<b>SECTION 4 – VOICEBLUE LITE CONNECTION TO VOIP.....</b>	<b>28</b>
4.1. SIP and H.323 Network Interconnection.....	29
4.2. Point-to-Point Configuration .....	29
4.3. Point-to-Multipoint Configuration.....	31
<b>SECTION 5 – IP VOICE TRANSMISSION.....</b>	<b>32</b>
5.1. Speech Coding Methods .....	33
5.2. SIP Components .....	35
5.3. SIP Reports .....	35

---

<b>CHAPTER 6 MOBILITY EXTENSION .....</b>	<b>38</b>
6.1. Advantages of function mobility extension.....	39
6.2. Activation of service mobility extension.....	39
6.3. Description of service mobility extension.....	39
Function “Follow me” .....	40
Function “SMS at no answer” .....	40
Function of forwarding call .....	41
Function of quick forwarding of call .....	42
6.4. Recording announcements for mobility extension.....	43
Recording of announcements using terminal and protocol Xmodem.....	44
6.5. Permitting service mobility extension.....	45
<b>SECTION 7 – 2N VOICEBLUE LITE ROUTING RULES .....</b>	<b>46</b>
7.1. Functions Supported by 2N VoiceBlue Lite .....	47
7.2. Call Routing Rules .....	47
7.3. LCR table.....	47
7.4. Call Routing to GSM via VoiceBlue Lite .....	48
7.5. Incoming calls from GSM to VoIP network .....	50
7.6. DISA Message.....	53
DISA Message Recording Using Terminal and GSM Phone.....	53
Recording DISA using terminal and protocol Xmodem .....	54
<b>SECTION 8 INTRODUCTION OF CONFIGURATION PROGRAM</b>	<b>56</b>
8.1. VoiceBlue Lite Configuration Program Installation .....	57
8.2. VoiceBlue Lite Configuration Program Running.....	57
8.3. Configuration Program Basic menu .....	60
File .....	60
Gateway control.....	61
Settings .....	61
Help.....	63
8.4. Button Bar .....	63
8.5. Topic List and Alphabetical Glossary .....	63
<b>SECTION 9 CONFIGURATION .....</b>	<b>66</b>
9.1. Establishing Communication with VoiceBlue Lite.....	67
Gateway selection.....	67
Communication setting.....	67
9.2. Firmware Identification and Upgrade .....	68
Firmware uploading.....	69
9.3. Gateway Licencing.....	70
9.4. Gateway control Items.....	71

---

Login account.....	71
Date/Time.....	71
Firmware / Licence .....	72
Tracing .....	72
Terminal .....	73
LOG file .....	73
Record on calls.....	74
Statistics .....	74
Voice message.....	75
GSM diagnostic.....	76
Actual calls.....	77
9.5. Gateway configuration.....	77
System parameters .....	78
SIP parameters .....	80
Basic GSM parameters.....	82
GSM groups assignment .....	84
GSM outgoing groups .....	84
GSM incoming groups .....	88
Network list.....	91
LCR table .....	91
Autorouting Table .....	94
Mobility extension .....	97
9.6. Reset.....	99
 <b>SECTION 10– CONFIGURATION OF EXTERNAL CALLBACK 100</b>	
10.1. Introduction to the External Routing Software.....	101
10.2. Installation and configuration of XAPI server.....	101
10.3. Entering licenses to XAPI server.....	104
10.4. Registering of users .....	105
10.5. Installing and configuration of Callback Centre.....	106
 <b>SECTION 11– CONFIGURATION USING TERMINAL.....110</b>	
11.1. Serial Communication Setting .....	111
11.2. USB Communication Setting.....	111
11.3. TCP/IP Communication Setting .....	111
11.4. Terminal Communication .....	112
11.5. GSM Gateway Behaviour .....	112
11.6. List of Terminal AT Commands.....	112
Basic AT commands .....	112
Extended user commands.....	113
Ethernet parameters:.....	114

---

Group parameters: .....	114
Pseudotarif params: .....	115
Network params:.....	116
Routing params:.....	116
Totals .....	116
Service AT commands:.....	117
Special GSM commands:.....	117
Work with SMS .....	119
11.7. Records on Operation (LOG) .....	120
11.8. Records on Calls (example).....	121
11.9. Statistics – Description .....	122
<b>SECTION 12 – TECHNICAL PARAMETERS .....</b>	<b>124</b>



## ■ Figures

---

Fig. 1 – Bottom View.....	8
Fig. 2 – Top View .....	9
Fig. 3 – Gateway Holder Wall-Mounting .....	11
Fig. 4 – Gateway Hanging .....	11
Fig. 5 – Direct PC Connection Using USB.....	13
Fig. 6 – Direct PC Connection Using RS232 .....	14
Fig. 7 – LAN Connection.....	14
Fig. 8 – RJ-45 Wiring for LAN Connection .....	14
Fig. 9 – Antenna Connection .....	15
Fig. 10 – Supply Adapter Connection.....	16
Fig. 11 – SIM Card Inserting Procedure .....	17
Fig. 12 – Signalling LEDs .....	18
Fig. 13 – Motherboard Diagram .....	21
Fig. 14 – SIP – H.323 Network Interconnection.....	29
Fig. 15 – Point-to-Point Configuration with SIP VoIP Telephone .....	30
Fig. 16 – Point-to-Point Configuration with VoIP Gateway .....	30
Fig. 17 – Point-to-Multipoint Configuration.....	31
Fig. 18 – SIP Message Sending while Connection Establishing and Terminating.....	37
Fig. 19 - Service mobility extension function “Follow me” .....	40
Fig. 20 - Service mobility extension function “SMS at no answer” .....	41
Fig. 21 - Service mobility extension function forwarding call .....	42
Fig.22 - Service mobility extension function quick forwarding .....	43
Fig. 23 – Routing of Outgoing GSM Calls .....	49
Fig. 24 – Incoming Call Processing Procedure.....	52
Fig. 25 - Main window of configuration program .....	57
Fig. 26 - Gateway list selection.....	58
Fig. 27 - Adding of new entry to gateway list .....	58
Fig. 28 - gateway control menu .....	61
Fig. 29 – Communication Setting Window .....	62
Fig. 30 – GSM Configuration Program Button Bar.....	63
Fig. 31 – Topic List (left) and Alphabetical Glossary (right) .....	64
Fig. 32 – Communication Setting Window .....	67
Fig. 33 – Firmware Window .....	69
Fig. 34 – Login Account Window .....	71
Fig. 35 – Date and Time Setting Window .....	71
Fig. 36 – Tracing Window .....	73

---

Fig. 37 – Window of Terminal Integrated in Configuration Program.....	73
Fig. 38 - Log window .....	74
Fig. 39 - Statistics window .....	74
Fig. 40 – Voice Message Recording Guide .....	75
Fig. 41 – Diagnostics .....	76
Fig. 42 – Call Information Displaying Window .....	77
Fig. 43 – System Parameters Window.....	78
Fig. 44 – Ethernet Parameter Configuring Window .....	80
Fig. 45 – Basic GSM Parameter Setting Window .....	82
Fig. 46 – Group Assigning Window.....	84
Fig. 47 – Outgoing Group Setting Window.....	84
Fig. 48 – Incoming Group Setting Window .....	88
Fig. 49 – GSM Calling Group Defining Window .....	91
Fig. 50 – LCR table .....	92
Fig. 51 – LCR table Completion.....	92
Fig. 52 – Callback function .....	95
Fig. 53 - Autorouting table .....	95
Fig. 54 – Add/edit autorouting numbers.....	96
Fig. 55 – Table mobility extension.....	97
Fig. 56 – Window of editing table of mobility extension.....	98
Fig. 57 – Scheme of external Routing system .....	101
Fig. 58 – Main XAPI server window .....	102
Fig. 59 - Communication configuration .....	102
Fig. 60 - SMS setup window .....	103
Fig. 61 - Status of GSM modules .....	103
Fig. 62 - Entering the licence.....	104
Fig. 63 - New user window .....	105
Fig. 64 - New user account properties .....	106
Fig. 65 - Voice Callback centre settings.....	107
Fig. 66 - Communication LOG.....	107
Fig. 67 - New user .....	108
Fig. 68 - User Groups .....	108





# 1

## SECTION 1

---

### **Product Presentation**

Here is a survey of what you will find in this section:

- Purpose
- How to Cut Telephone Costs
- Other Advantages and Applications
- RF Radiation Safety Precautions

---

## 1.1. Purpose

- The 2N - VoiceBlue Lite gateways help interconnect SIP based VoIP networks directly with GSM networks. They can also be used for a direct connection with a VoIP telephone set.
- The voice mode, i.e. an outgoing or incoming call, is the basic function of the system. The gateway is equipped with all functions necessary for such use and provides a very high comfort in this mode.
- In addition to voice transmission, the 2N - VoiceBlue Lite gateways enable to send and receive SMS messages.
- No extra equipment (an external GSM telephone, etc.) is needed for normal operation. To set the basic parameters use the configuration software included in the product CD. All programmable parameters are default-preset in such a manner that you can commence your telephone traffic the moment you connect the Ethernet and supply cables, antenna and SIM card and set the GSM and VoIP parameters.

## 1.2. How to Cut Telephone Costs

- Once you connect the 2N – VoiceBlue Lite gateway to your VoIP PBX, you can make all outgoing calls to a mobile network directly. **Thus, you cut your PSTN - mobile network call costs.** All mobile telephone calls from your personnel in the field are cheaper too.
- You are advised to use the **most advantageous rate of your GSM provider** for your GSM gateway because all gateway user call accounts are added up for billing purposes.
- You can bar selected numbers or groups of numbers in your gateway. **You shall pay nothing for the calls you have barred.**
- 2N - VoiceBlue Lite keeps detailed records on all calls. This helps you **find out easily why your bill is higher than it should be.**
- The Least Cost Router is flexible enough to help you set rules for **GSM calling at the lowest possible operation costs.**

- **The intelligent Callback function** enables your personnel to call at the cost of your GSM gateway SIM cards.

### 1.3. Other Advantages and Applications

- 2N - VoiceBlue Lite integrates the best of the GSM and VoIP communication technologies.
- The GSM gateway keeps detailed statistics on incoming and outgoing calls.
- With the **Compact Flash** memory you get an almost unlimited depository for your call records.
- The **Intelligent Routing of Incoming Calls** function accelerates the incoming call establishing and provides a higher calling comfort.
- The DISA function with the option to record easily a welcome note is available.
- You can use the conditioned or unconditioned call forwarding function.
- You can disable the CLIP function on your GSM telephone set.
- Unlike mobile telephones, this system does not expose you to the RF electromagnetic field while making calls.
- All functions may be configured through the Ethernet, USB and serial interfaces.
- With the aid of external software, you can implement your VoiceBlue Lite gateway into the Unified Messaging system of your company.

---

## 1.4. RF Radiation Safety Precautions



It is prohibited to use any transmitters, including VoiceBlue Lite, in areas where explosives are used, such as quarries.

It is forbidden to use mobile phones and thus VoiceBlue Lite too at refuelling points.

A GSM gateway may affect sensitive life-saving devices in medical centres. So it is prohibited to use mobile phones and thus VoiceBlue Lite here.

In general, any restriction regarding mobile phones based on RF energy radiation applies to GSM gateways.

Where necessary, VoiceBlue Lite may be installed at a safe distance (in the neighbouring building, e.g.) and an Ethernet cable may be carried from the GSM gateway to the original building.

Although GSM gateways are not intended for aircraft or cars, all relevant restrictions and regulations regarding mobile phones apply to them here.



# 2

## SECTION 2

---

### **Installation**

This section deals mainly with the proper mounting of the 2N - VoiceBlue Lite and its connectors. One subsection is devoted to the lithium battery replacement.

Here is a survey of what you will can in this section:

- Get Started
- Brief Installation Guide
- Proper Mounting
- PC or LAN Connection
- Antenna Connection
- Gateway Power Supply
- SIM Card Installation/Removal
- PIN Entering Disable (Optional)
- Status Indicators

- 
- Lithium Battery Replacement
  - Fuse Replacement
  - Antenna Splitter

## 2.1. Get Started

Before you start installing your VoiceBlue Lite gateway, get familiar with its physical structure, arrangement of connectors and status indicators; see Fig. 1, Fig. 2, and Fig. 12.

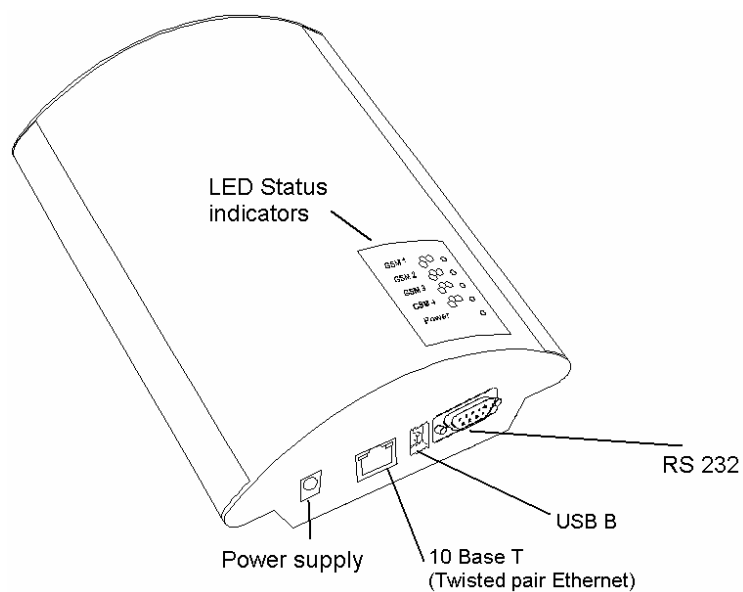

Fig. 1 – Bottom View

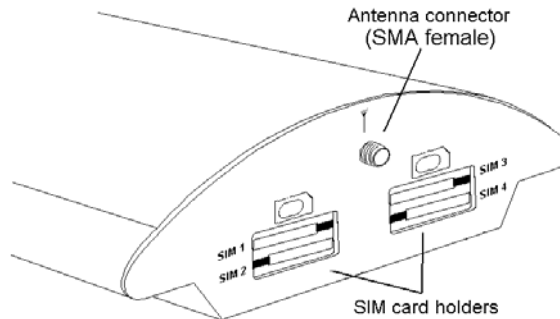

Fig. 2 – Top View

## 2.2. Brief Installation Guide

- **Proper mounting** – 2N – VoiceBlue Lite is designed for suspension on a vertical surface. Fit the holder included in the delivery on a wall and hang the gateway on it. For details on the prescribed working position and other recommendations refer to Subs. 2.3.
- **Cable connection** – connect the gateway using an Ethernet cable to your VoIP PBX (or any other VoIP terminals). For more details on proper wiring refer to Subs. 2.4.
- **Antenna connection** – connect an external antenna cable into the SMA antenna connector. Place the antenna on a place with a good GSM signal (refer to Subs. 2.5).
- **Gateway power supply** – the delivery includes a mains adapter. Make sure that an antenna has been attached to the antenna connector before supplying voltage. Plug in the adapter connector into the GSM gateway and the power adapter into a wall socket. The gateway turns on immediately (see Subs. 2.6).

- 
- **SIM card insertion** – SIM cards are inserted in holders on the gateway top. The SIM card holder is of the push/pull type, which means that all you have to do is insert a SIM card and press the holder gently until it snaps into position (see Subs. 2.7). Secure the SIM card with a latch to avoid incidental removal. **!CAUTION! If you use PIN-asking SIM cards, first set an identical PIN code for all SIM cards used in the GSM gateway, save it into the GSM gateway configuration and only then insert the SIM cards in the GSM gateway.**
  - **PC connection** – the gateway parameters are normally set using the configuration software available on the CD included in the delivery. To interconnect your PC with 2N - VoiceBlue Lite use the USB cable<sup>\*</sup> or laplink RS 232 cable<sup>\*\*</sup> included in the delivery.
  - **Configuration program installations - run the installation file from the installation CD on a PC connected to the gateway and install** the VoiceBlue Lite configuration software (refer to Subs. 0).
  - **Configuration program** - run the VoiceBlue Lite program and set the serial port communication for your PC - gateway connection. Establish communication between your PC and the gateway (refer to Subs. ).
  - **2N - VoiceBlue Lite configuration** - now use the configuration software to set all necessary gateway parameters - VoIP parameters basic GSM parameters and tariff metering/pricing parameters, routing, restrictions, system parameters, and input and switch properties. Having set the required parameters, upload the configuration data to the gateway via a serial link. For more details on the configuration software see Section 9.

---

<sup>\*</sup> Be sure to install the drivers available on the CD included when you use a USB cable.

<sup>\*\*</sup>of the same type as used for direct PC-PC connection.

## 2.3. Proper Mounting

- The 2N - VoiceBlue Lite gateway is designed for mounting on a vertical surface. For this purpose a wall- mounting holder is available. Just fit the holder with dowels and screws (Fig. 3) to the wall and hang the gateway as shown in (Fig. 4).

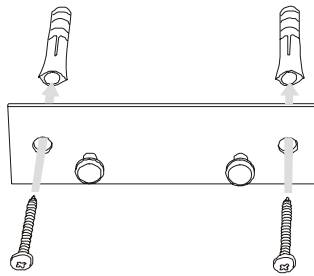

Fig. 3 – Gateway Holder Wall-Mounting

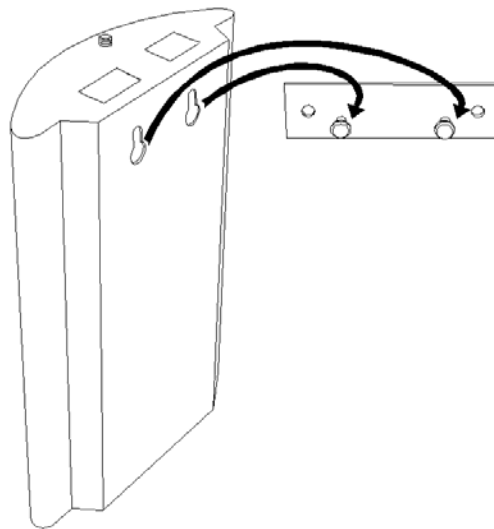

Fig. 4 – Gateway Hanging

- It is possible to operate the VoiceBlue Lite gateway in another working position (e.g. on a desk) for a short time only, for example in servicing centres for quick testing purposes.

- 
- Exceeding the recommended operating temperature values may not affect the gateway function immediately but may result in more rapid ageing and lower reliability. The allowed working temperature and relative humidity ranges are included in Section 12.
  - The gateway is intended for indoor use. It may not be exposed to rain, flowing water, condensed moisture, fog, or mist.
  - The gateway may not be exposed to aggressive gas, acid vapours, solvents, etc. or aggressive liquids, during cover cleaning, for example.
  - The VoiceBlue Lite gateway is not designed for high-vibration environments e.g. means of transport, machine rooms, etc.
  - Free space has to be left under and over the gateway for cables and agitated air to remove operational heat.
  - Install the gateway on a place with a good GSM signal.
  - A misplacement of the GSM gateway or its antenna near television, broadcasting or similar RF-sensitive devices may evoke an adverse effect upon their function.
  - Being a source of RF energy emission, the VoiceBlue Lite gateway antenna should not be located close to human bodies. The hazard is higher than with mobile telephones because the gateway is usually used by many people and thus employed more often.

## **2.4. PC or LAN Connection**

The 2N - VoiceBlue Lite gateway can be connected to a PC using a USB cable terminated with a USB B connector or a laplink serial cable with RS 232 connectors. A direct connection of 2N - VoiceBlue Lite and a PC is necessary for the initial gateway configuration when the gateway IP address is unknown and the gateway cannot be configured using the LAN.

VoiceBlue Lite supports connection via the Universal Serial Bus (USB) of version 1.1. In this type of connection, however, it is necessary to install VoiceBlue Lite drivers into your operating system (OS). At present, the drivers support the Microsoft

Windows 98SE/ME/2000/XP OS. While installing the drivers please following the instructions below:

- Insert the included CD into your PC CD-ROM drive.
- Connect the USB cable to the PC and then to VoiceBlue Lite.
- The Windows OS recognises the connected device automatically and asks for suitable drivers.
- Find the VoiceBlue Lite drivers on the CD included in the delivery in the following directory: ***CDROM:\VoiceBlue\USB drivers.***
- The OS recognizes the right drivers automatically and starts installing them.

The OS may also require the USB COM port drivers. They are available in the same CD directory as mentioned above.

The VoiceBlue Lite gateway operates as a modem in the data mode, communicating through a virtual COM port. The gateway USB port default parameters are 921,600 bps, 8 data bits, no parity, 1 stop bit, and no flow control. If you intend to use the USB cable for distances longer than 5 meters, you are recommended to use the USB hubs.

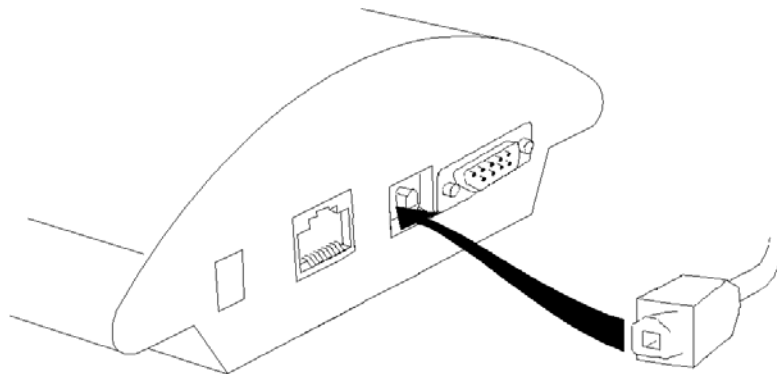

Fig. 5 – Direct PC Connection Using USB

The serial port transmission rate is 57,600 bps, the remaining communication parameters are the same. Set the communication parameters on the PC side identically.

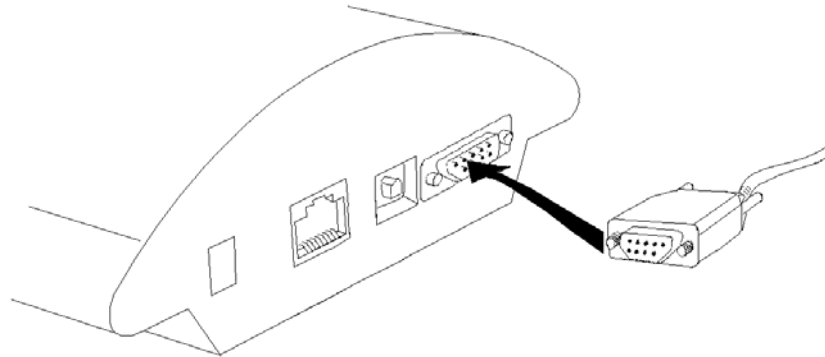

Fig. 6 – Direct PC Connection Using RS232

A standard straight through cable terminated with RJ-45 connectors is used for connection to the 10BASE-T (Twisted Pair Ethernet) LAN (Fig. 7 and Fig. 8).

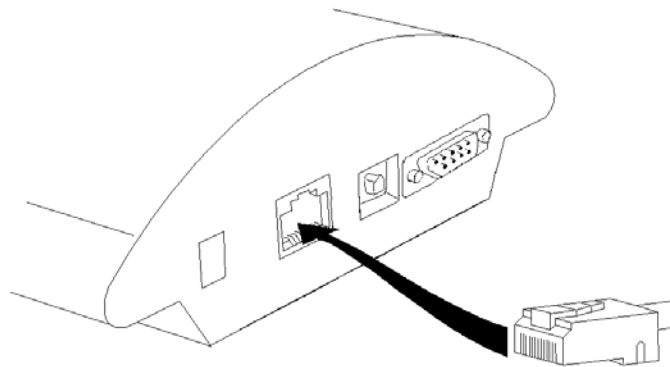

Fig. 7 – LAN Connection

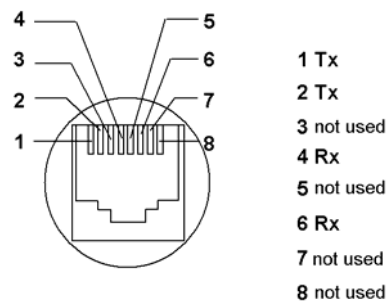

Fig. 8 – RJ-45 Wiring for LAN Connection



## 2.5. Antenna Connection

The VoiceBlue Lite gateway has one SMA antenna connector for all GSM modules, see Fig. 9. An external antenna cable is connected to this connector. The external antenna should be installed vertically on a place with a good GSM signal. For the technical parameters of the antenna refer to Section 12.

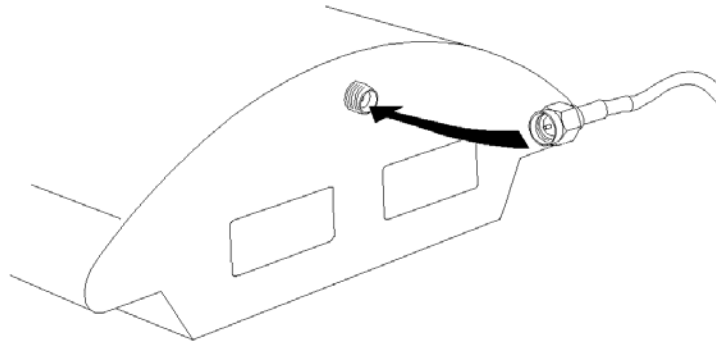

Fig. 9 – Antenna Connection

Tighten the antenna connector gently with your hand, never use a wrench!

## 2.6. Gateway Power Supply

- Be sure to use only the mains supply adapter that is included in the gateway delivery.
- Before plugging in the gateway, make sure that the mains voltage value meets the data given on the mains adapter label.
- Make sure that the antenna has been connected. **If you connect the gateway to the power supply without an antenna, the GSM module transmitter might get damaged.**
- Now plug the supply adapter into a wall socket and after it connect the adapter connector to the gateway, see Fig. 10. The status indicators indicate the proper operation. For their meanings refer to Subs. 2.9.

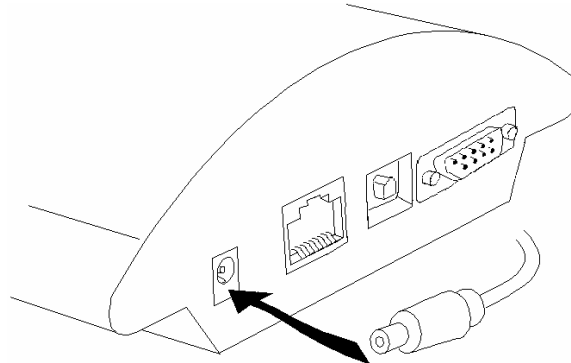

Fig. 10 – Supply Adapter Connection

## 2.7. SIM Card Installation/Removal

Insert the SIM card into the SIM card slots with your hand as shown in Fig. 11. Please make sure that the slashed SIM card side is on a side opposite to the latch. Having inserted the SIM card, push the card gently until you hear a click signalling that the push/pull holders have snapped the card. Secure the SIM card by shifting the latch to the right in order to avoid incidental removal of the SIM card.

To remove the SIM card take the opposite steps. You can replace a SIM card even with the gateway on.

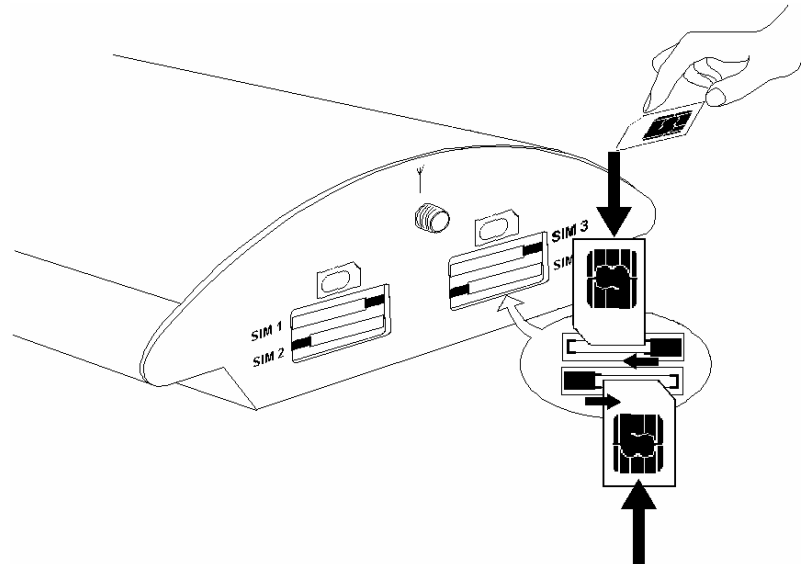

Fig. 11 – SIM Card Inserting Procedure

Each SIM card inserted in the gateway has a unique set of parameters. Their values are bound to the card IMSI, remain stored in the gateway even if the SIM card has been removed and thus need not be reset upon SIM card re-insertion.

## 2.8. PIN Entering Disable (Optional)

2N - VoiceBlue Lite is set at automatic PIN entering by default (1234). To disable the PIN use any mobile telephone in which you insert the given SIM card. By disabling the PIN entering you invalidate any other VoiceBlue Lite parameters or PIN stored in the gateway memory. If you do not disable this function, VoiceBlue Lite will always ask for a PIN by LED signalling, which must be identical for all SIM cards inserted.

## 2.9. Status Indicators

There is a panel with five LEDs on the gateway upper cover for a quick GSM gateway status detection (see Fig. 12). The *Power* LED signals that the gateway as a whole is in operation. The *GSM 1* to *GSM 4* LEDs indicate the status of the respective GSM modules.

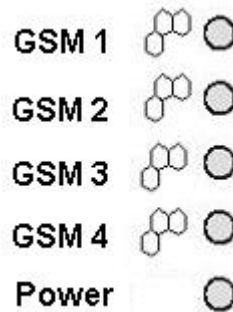

Fig. 12 – Signalling LEDs

Basic diagnostic tests and gateway initialisation are performed automatically whenever the gateway is connected to supply voltage. Each test step is signalled by a specific colour combination of the LEDs. If a test step fails, the indicator combination related to the failed test remains lighted.

### Power Indicator

The *Power* LED signals whether the VoiceBlue Lite gateway is supplied or not.

<i>Power indicator (blue)</i>	
<b>Power</b>	<b>LED colour/status</b>
No light	The system is not working. / Blown fuse / Wrong power supply
Continuous light	The system is working.

Tab. 1 – Survey of *Power* Indicator Statuses

### GSM Indicators

The *GSM 1* to *GSM 4* LEDs signal statuses of the respective GSM modules. Whenever the 2N - VoiceBlue Lite is started, detection of the GSM modules is carried out. This process is signalled by a green LED. If all GSM modules are present and ok, the LED goes out. After that the firmware and configuration uploading process is initiated, which is signalled by various LED colour combinations. The initialisation process is followed by a check of presence of SIM cards in slots. Quick blinking of the green LED of the respective GSM module indicates this procedure. If a GSM

module or a SIM card is absent, the red LED remains lighted. If a GSM module is not supplied, the respective GSM LED is blinking red. Upon a correct GSM module initialisation, the SIM card is logged in, which is signalled by a quickly blinking green LED. If the log-in has been successful, the LED goes out. If not, it shines red continuously.

In normal operation, a continuous green LED indicates an incoming or outgoing call within the particular GSM module.

---

A survey of GSM module status signalling is included in Tab. 2.

<b>GSM Indicators</b>	
<b>GSM 1 to GSM 4</b>	<b>LED Colour/Status</b>
The module is ready	No light
Call establishing	Green / shining
Currently made call	Green / shining
Module initialisation	Green / blinking slowly 1:3
SIM card initialisation	Green / blinking quickly 1:1
GSM module / SIM card absent	Red / shining
GSM module not supplied	Red / blinking quickly

Tab. 2 – Survey of GSM Module Status Signalling

## 2.10. Lithium Battery Replacement



### **Limited warranty on accumulators**

The warranty on batteries (accumulators) supplied separately or as part of a product or together with a product does not also apply to wear and tear of accumulators and their components as a result of normal use (e.g. discharge of the battery, reduction of the accumulator capacity as a result of wear and tear) as fact that may not be deemed as a lack of conformity with the contract of sale in accordance with Article 2 of Directive 1999/44/EC of the European Parliament and of the Council.



**WARNING! An incorrect battery replacement may result in explosion.** For replacement, batteries of the same or equivalent type as recommended by the manufacturer may be used only. **The battery type is CR2032.**

**WARNING!** Never use metal tools for battery replacement to avoid short-circuit. Battery short-circuiting may result in battery destruction or explosion.

Keep the proper battery polarity.

Dispose of used batteries in accordance with applicable waste regulations, for example in waste recycling centres.

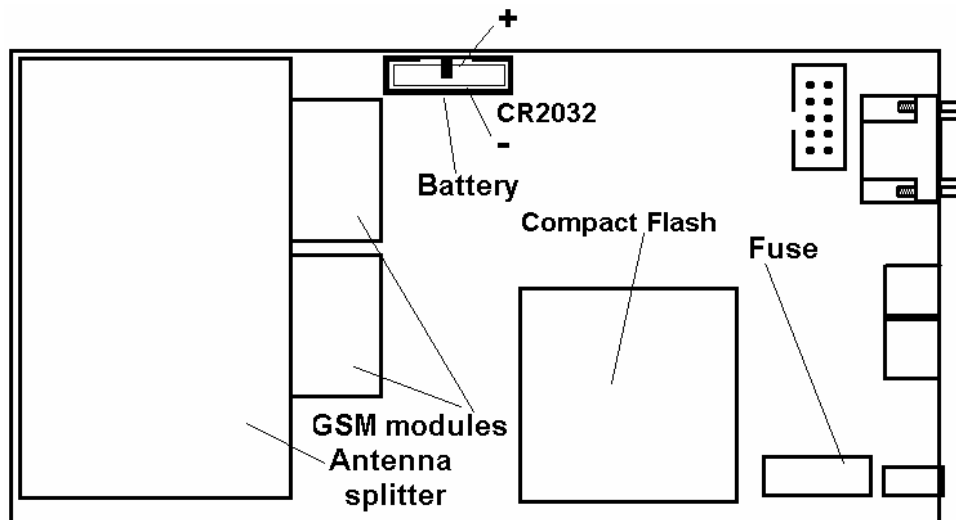

Fig. 13 – Motherboard Diagram

It is unnecessary for the gateway function. Its average service life is approximately 3 years. You are recommended to replace it after three years for preventive purposes or, at least, check the voltage with a voltmeter (the value should not drop below 2.9V). A completely low battery results in the VoiceBlue Lite gateway losing the time and date information and false data appear in the trace and also in the service log buffer listing.

---

To replace the lithium battery, first disconnect your VoiceBlue Lite gateway from the mains and open the cover. Remove the old battery from the holder using a suitable tool and install a new one. We recommend you to have this service done by a 2N servicing centre.

## 2.11. Fuse Replacement



**WARNING! Use only a fuse of the same type.**

Disconnect the adapter power while replacing the fuse.

Fuse can be replaced only by service which is personnel qualified to check such parameters as power consumption, DC voltage etc.

If fuse fails again, unit must be returned to manufacturer for repair

To exchange the fuse disconnect power adapter cable first. The location of the fuse on the main board is on the Fig. 13. Open the cover, remove the faulty fuse and check it. **Replace the fuse by a fuse of the same type only.** Close the cover and reconnect the power adapter cable.

## 2.12. Antenna Splitter

The antenna splitter is a passive component that enables several GSM channels to share a single antenna. With VoiceBlue Lite it joins four antenna ports into one external antenna. This splitter saves both antenna costs and installation space. It is a passive element – it has a characteristic signal attenuation that the connected antenna must compensate. For technical parameters of the splitter and antennas refer to Section 12.





---

# 3

## SECTION 3

---

### **2N - VoiceBlue Lite Installation**

This section shows how to install the VoiceBlue Lite gateway properly to avoid gateway operation troubles.

This section includes:

- Proper Installation Conditions
- VoiceBlue Lite Installation
- Potential GSM Network Problems

### 3.1. Proper Installation Conditions

The following installation conditions must be met for a proper function of VoiceBlue Lite:

- Sufficient space for VoiceBlue Lite installation.
- Sufficiently strong signal from the GSM network with which VoiceBlue Lite shall work with (the minimum signal intensity value is **-80dBm**). To measure the signal intensity before VoiceBlue Lite installation you can use a mobile telephone with the *Net monitor* function enabled (e.g. SIEMENS, NOKIA).
- A corresponding capacity of the GSM network (no GSM cell overloading). Remember that the use of multiple GSM gateways in one location may overload your current GSM cell base. This might lead to a permanent or occasional rejection of calls to GSM networks!
- No strong electromagnetic radiation on the installation site.
- No strong reflections on VoiceBlue Lite antenna sites.
- A correct VoIP connection configuration according to SIP and other VoIP recommendations.

### 3.2. VoiceBlue Lite Installation

- Place the VoiceBlue Lite GSM gateway to an environment that meets the gateway working conditions.
- It is recommended to connect the supply adapter with a battery backup (UPS) and appropriate surge protection.
- Configure the GSM gateway using the VoiceBlue Lite software available on the product CD enclosed.
- You may use remote GSM gateway administration through the Ethernet for a comfortable GSM gateway management.

---

### 3.3. Potential GSM Network Problems

The VoiceBlue Lite GSM gateway is designed for a continuous 100% load. The GSM network may cause the following problems:

- The GSM module(s) cannot log in, log in slowly or log out occasionally. This might be caused by any of the events below:
  - The signal intensity received from the GSM network is too weak – the recommended minimum value is **-80dBm**. If the signal is lower, change the antenna position or type.
  - The GSM cell to which the GSM modules log in is overloaded. Change the antenna position, or reduce the number of GSM channels connected to the troubled GSM network.
- One of the GSM modules keeps logged out or is unable to process an outgoing call – this indicates a potential GSM network overload on the installation site. To solve this problem, set the parameter “*Relax delay*” = 2. If a GSM module fails to log in or refuses to process a GSM call even after the gateway restart, check your GSM network provider for potential SIM card or GSM module blocking.



---

# 4

## SECTION 4

---

### **VoiceBlue Lite Connection to VoIP**

This section discusses VoIP connection possibilities of the 2N - VoiceBlue Lite gateway. Since 2N - VoiceBlue Lite communicates using the SIP only, the interconnection of SIP and H.323 networks is mentioned here too. 2N - VoiceBlue Lite may be operated in the Point-to-Point or Point-to-Multipoint mode with a SIP Proxy server.

This section includes:

- SIP and H.323 Network Interconnection
- Point-to-Point Configuration
- Point-to-Multipoint Configuration

## 4.1. SIP and H.323 Network Interconnection

SIP-based devices cannot communicate with H.323-based ones directly but through a SIP/H.323 gateway. This gateway transfers signalling reports of both the protocols. Using the RTP (Real Time Protocol) for multimedia data transmission, both SIP and H.323 devices can communicate directly with each other after getting interconnected by a SIP/H.323 gateway. Therefore, 2N - VoiceBlue Lite may be implemented into the existing H.323 environment using a SIP/H.323 gateway.

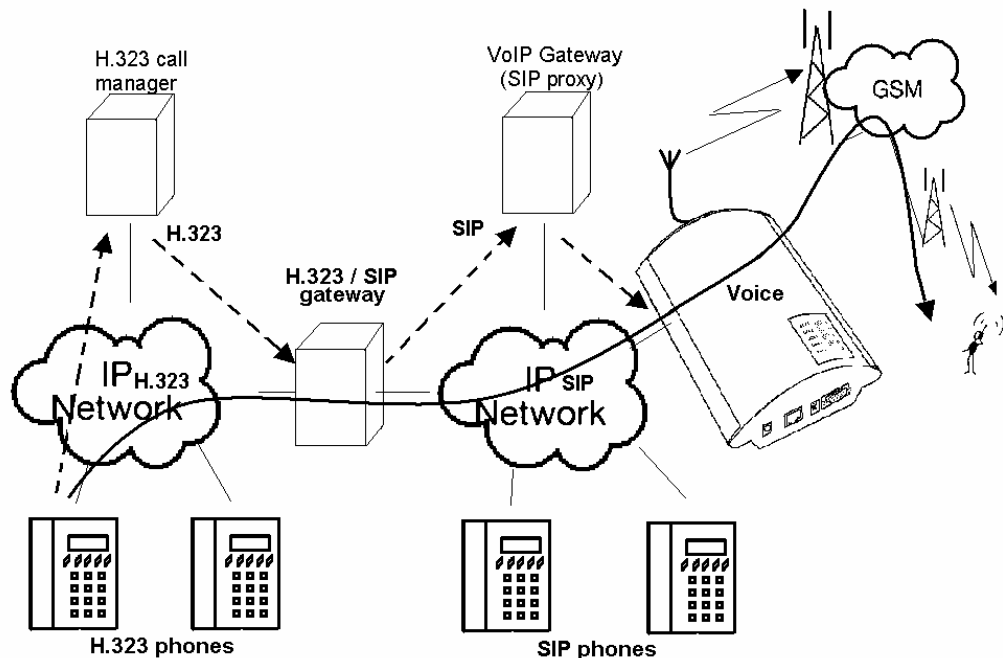

Fig. 14 – SIP – H.323 Network Interconnection

## 4.2. Point-to-Point Configuration

In the Point-to-Point mode, VoiceBlue Lite can only communicate with one SIP VoIP telephone or another SIP VoIP terminal, e.g. a VoIP gateway. The IP address of the opposite side is always set as the Proxy server IP address in the VoiceBlue Lite P-T-P mode.

---

The VoiceBlue Lite configuration with one SIP VoIP telephone is often used for testing purposes before implementation to the VoIP network. For this connection see Fig. 15.

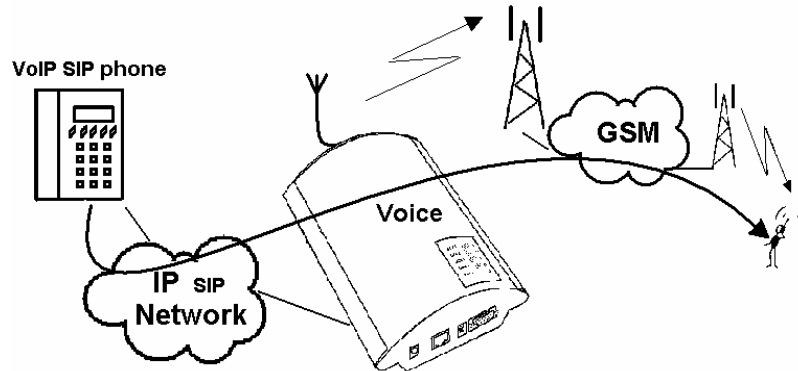

Fig. 15 – Point-to-Point Configuration with SIP VoIP Telephone

In the Point-to-Point mode using a VoIP gateway, all calls assigned to GSM are routed to VoiceBlue Lite by the VoIP gateway. You can either set the IP address of the opposite side as the Proxy server IP address for the two terminals, or, with an intelligent VoIP gateway, resend certain calls to the VoiceBlue Lite IP address directly.

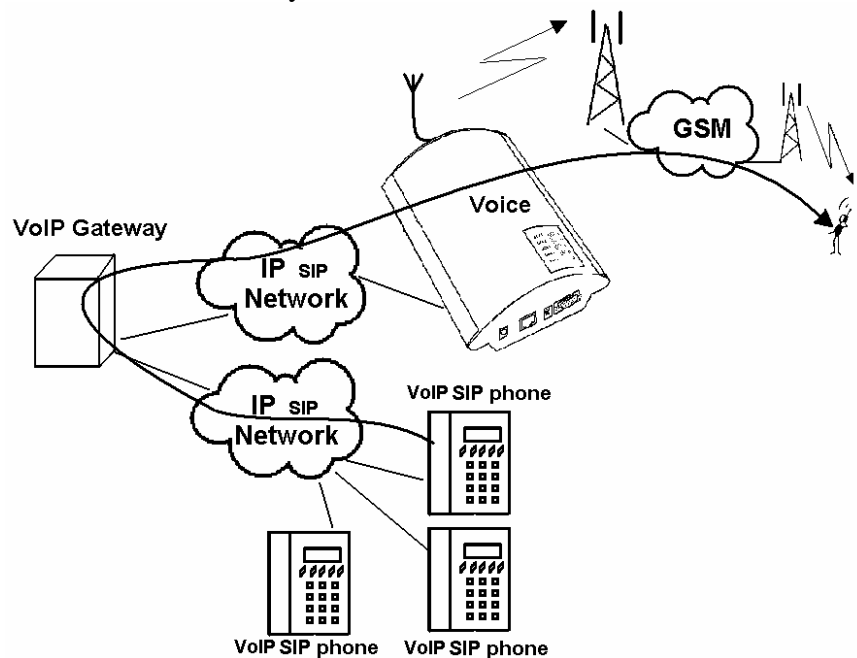

Fig. 16 – Point-to-Point Configuration with VoIP Gateway



### 4.3. Point-to-Multipoint Configuration

The Point-to-Multipoint arrangement means a classical structure of a distributed VoIP network with one or more SIP Proxy servers (VoIP gateways). The SIP Proxy is a software PBX version (or a standard PBX enhanced with VoIP services), which manages all signalling in the VoIP network. In this mode you can use multiple source terminals (e.g. VoIP telephones) and multiple destination terminals (e.g. VoiceBlue Lite). An internal routing algorithm (LCR) of your SIP Proxy is used for routing calls to GSM and other networks. GSM calls may be routed through the VoiceBlue Lite gateway. All signalling (SIP) is managed by the SIP Proxy and the subsequent voice stream is transmitted by the RTP in the Point-to-Point mode.

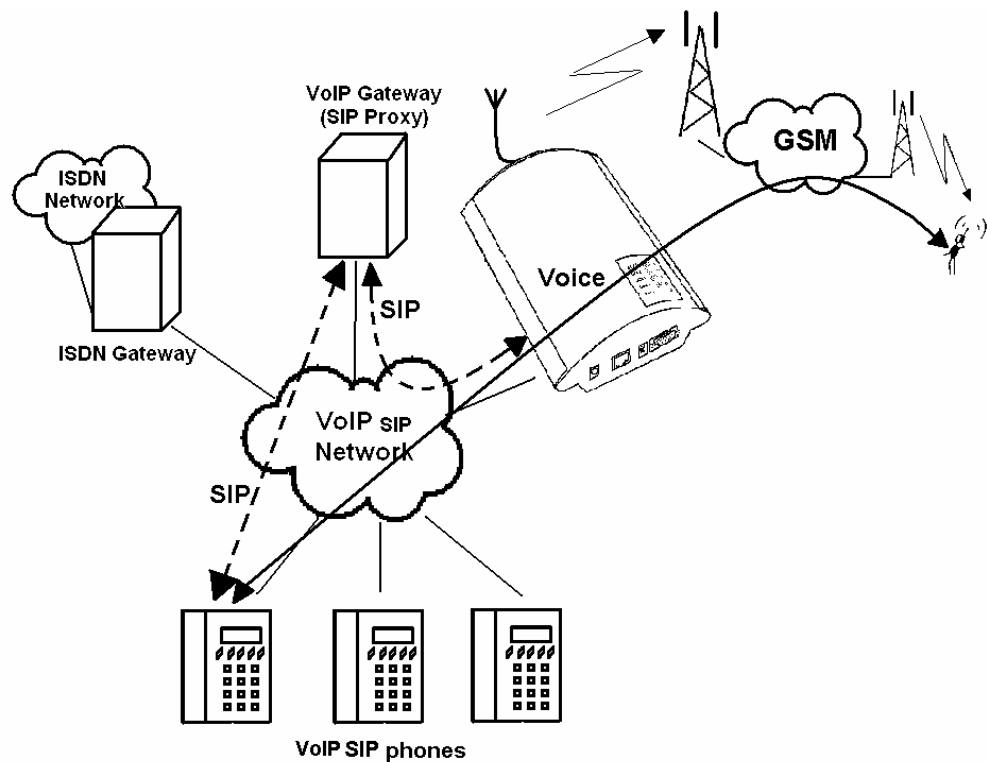

Fig. 17 – Point-to-Multipoint Configuration

---

# 5

## SECTION 5

---

### **IP Voice Transmission**

This section explains voice coding in IP networks. Moreover, essential facts are mentioned on establishing connection between two SIP-based IP telephones.

This section includes:

- Speech Coding Methods
- SIP Components
- SIP Reports

## 5.1. Speech Coding Methods

Voice and signal transmission is strictly separated in VoIP networks. The RTP (Realtime Transport Protocol) is mostly used for voice transmission in modern VoIP networks. The purpose of the RTP is to transmit data from the source to the destination and ensure the real time data (voice) transmission.

Codecs are used to save capacity of data channels, processing the voice signal using various algorithms with the aim to minimise the volume of user data. The degree of compression used by codecs influences the quality of voice to be transmitted. This means that the higher voice quality is required, the wider data band (transmission rate) should be used. The voice transmission quality is evaluated using the Mean Opinion Score (MOS) where 1 means the lowest and 5 the best quality. A survey of codecs supported by VoiceBlue Lite is included in Tab. 3.

Codecs Supported by 2N - VoiceBlue Lite			
Standard	Algorithm	Transmission rate [kb/s]	MOS
G.711	PCM	64	4.1
G.726	ADPCM	32	3.85
G.729	CS-ACELP	8	3.92
G.723.1	ACELP	5.3	3.65

Tab. 3 Table of Codecs Supported by 2N<sup>®</sup> - VoiceBlue Lite

To achieve a high-quality voice transmission requires not only keeping of a constant necessary transmission rate during the whole connection but also a constant low data packet transmitting time.

---

\* Multiple the above mentioned rate by eight (four full duplex calls) and add the transmission rate necessary for the TCP and IP header to the resultant value for to get a successful 2N<sup>®</sup> - VoiceBlue Lite Lite connection.

- 
- G.711 – this codec is used in digital telephone networks. The Pulse Code Modulation (PCM) is used for speech signal coding. The sampled signal is coded by 12 bits and then compressed to resultant 8 bits using a transformation characteristic. The A-law compression is used in Europe, and  $\mu$ -law compression in North America and Japan. The resultant data flow is 64 kbps.
  - G.726 – this codec uses the Adaptive Differential Pulse Code Modulation (ADPCM). This algorithm provides compression of 8-bit samples of codec G.711 into 2, 3, 4 and 5-bit samples with the resultant transmission rate of 16, 24, 32 and 40 kbps.
  - G.729 – this codec uses the Conjugate-Structure Algebraic-Code-Excited Linear-Prediction (CS-ACELP) with the resultant transmission rate of 8 kbps. The speech signal is split up into blocks of 10 ms each. The parameters of these blocks are then entered into frames of the size of 10 bytes. 2 byte frames are generated for noise transmission.
  - G.723.1 – this codec uses the Multipulse Maximum Likelihood Quantisation (MP-MLQ). The voice signal is split up into 30 ms blocks and coded into 24 byte frames with the resultant data flow of 6.3 kbps. Another coding algorithm is the Algebraic Code-Excited Linear Prediction (ACELP), which provides coding of 30 ms blocks of speech into 20 byte frames with the resultant transmission rate of 5.3 kbps. 4 byte frames are used for noise transmission.

During call establishing, a codec is selected automatically for voice transmission. 2N - VoiceBlue Lite is ready to use any of the codecs included in Tab. 3. The type of coding depends on your VoIP network (terminals) and VoiceBlue Lite GSM gateway configuration. The primary purpose of 2N - VoiceBlue Lite is to provide connection to corporate VoIP networks and it tries to meet the opposite side's codec requirements. If a codec incompatible with VoiceBlue Lite is required, the call is rejected.

The IETF SIP and ITU-T H.323 protocols are mostly used for making, maintaining and terminating connections. The 2N - VoiceBlue Lite gateway uses the SIP (Session Initiation Protocol).

## 5.2. SIP Components

SIP reports are transmitted between the following components:

- UAC (User Agent Client) – a terminal Client that initiates SIP signalling;
- UAS (User Agent Server) – a terminal Server that responds to SIP signalling from a UAC;
- UA (User Agent) – a SIP network terminal (SIP telephone, or gateway to other networks), contains a UAC and UAS;
- Proxy server – receives connection requests from a UA and transfers them to another Proxy server if the particular station is beyond its control;
- Redirect server – receives connection requests and sends them back to the requester including destination data instead of sending them to the calling party;
- Location server – receives registration requests from the UA and updates the terminal database with them.

All server sections (Proxy, Redirect, Location) are typically available on a single physical machine called Proxy server, which is responsible for client database maintenance, connection establishing, maintenance and termination, and call directing.

The 2N - VoiceBlue Lite gateway is always a UA (has the same functions as a VoIP telephone), i.e. receives call requests and directs calls to GSM networks according to the internal LCR.

There are no SIP-defined server sections in the 2N - VoiceBlue Lite gateway.

## 5.3. SIP Reports

Here is a list of main signalling reports sent in the SIP environment:

- INVITE – connection establishing request;
- ACK – acknowledgement of INVITE by the final message receiver;
- BYE – connection termination;

- 
- CANCEL – termination of non-established connection;
  - REGISTER – UA registration in SIP Proxy;
  - OPTIONS – inquiry of server options.

Replies to SIP messages are in the digital format like in the http protocol. Here are the most important ones:

- 1XX – information messages (100 – Trying, 180 – Ringing, 183 - Progress);
- 2XX – successful request completion (200 – OK);
- 3XX – call forwarding, the inquiry should be directed elsewhere (302 – Temporarily moved, 305 – Use Proxy);
- 4XX – error (403 – Forbidden, 486 – Busy here);
- 5XX – server error (500 – Server Internal Error, 501 – not implemented);
- 6XX – global failure (606 – Not Acceptable);

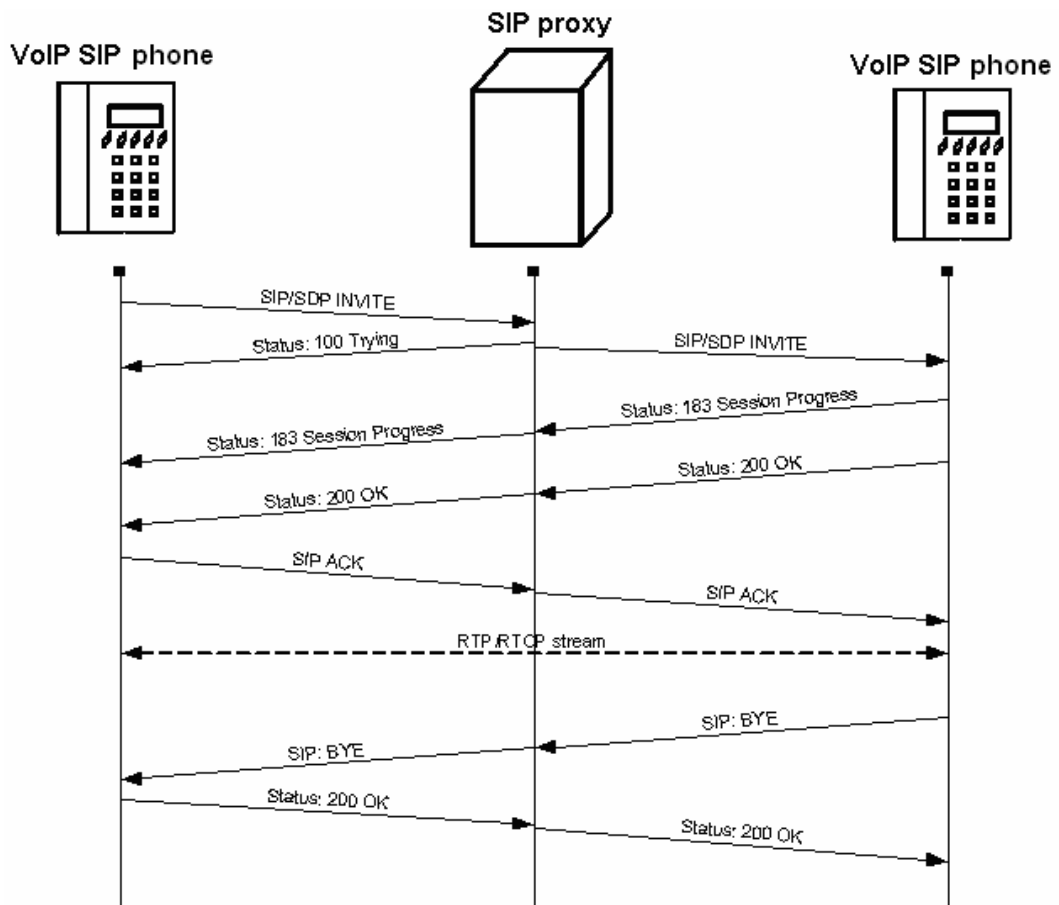

Fig. 18 – SIP Message Sending while Connection Establishing and Terminating

---

# 6

## CHAPTER 6

---

### **Mobility extension**

The function mobility extension (ME) allows the rerouting of a call from VoIP to the GSM network if a subscriber is unavailable in the VoIP network. Apart from this function it allows the holding of a call and forwarding calls from the GSM to VoIP network.

In this chapter you will find:

- Advantages of function mobility extension
- Activation of service mobility extension
- Description of service mobility extension
- Recording announcements for mobility extension
- Permitting service mobility extension



## 6.1. Advantages of function mobility extension

- Never miss an important call, you are always available
- Possibility of sending information text announcement if a call is missed
- You have the services of rerouting SIP proxy on a mobile telephone
- Comfort control using DTMF option
- Fully automatic function, it is not necessary to perform any complex rerouting
- Functional with any SIP proxy
- Installation in place of any VoIP telephone
- Calls to your mobile telephone are free or for a slight charge as a result of the service VPN
- You need no longer worry about the integration of an expensive DECT system
- High voice quality EFR/AMR

## 6.2. Activation of service mobility extension

The function mobility extension is an added value of the of 2N<sup>®</sup> VoiceBlue Lite, and it can be activated using a licence key. In order to receive a licence key, please contact your distributor. The licence key is entered in the GSM gate from the terminal window (see chapter 9.4) using an AT order.

## 6.3. Description of service mobility extension

The service mobility extension allows the rerouting of calls from the VoIP network to the GSM network in the case of the unavailability of the subscriber in the VoIP network. If the function mobility extension is permitted for a given subscriber, it is possible to switch off/on the rerouting of calls using the DTMF option from the GSM network.

---

## Function “Follow me”

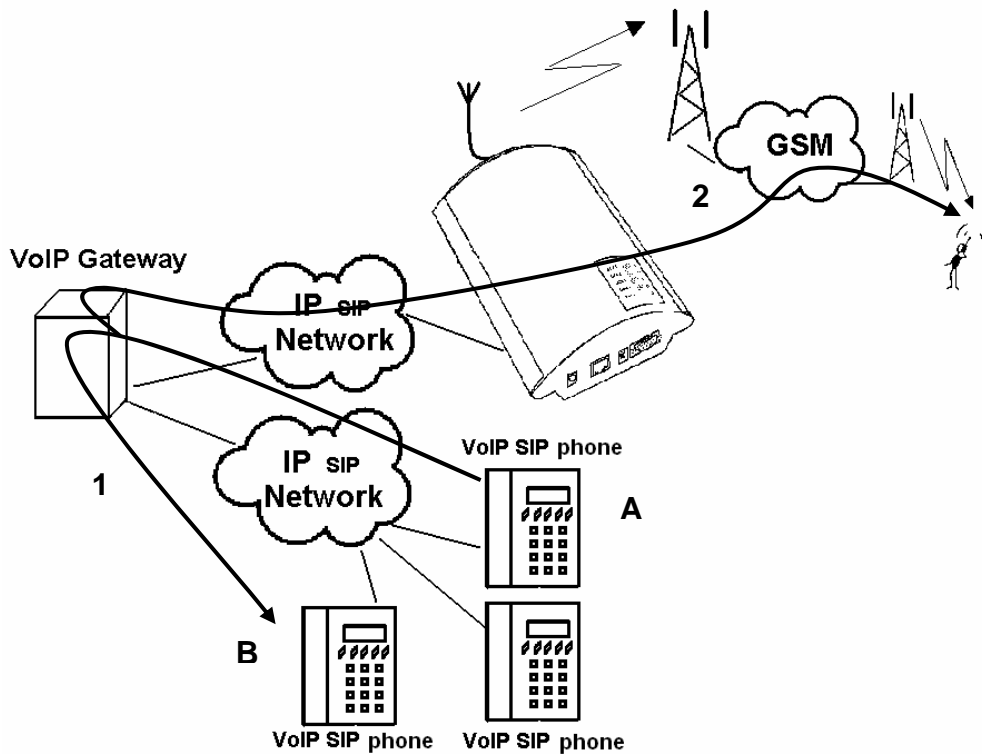

Fig. 19 - Service mobility extension function “Follow me”

Fig. 19 shows the routing of calls in the case of the absence of a subscriber in the VoIP network. Subscriber A calls subscriber B, who has the service mobility extension permitted with the active function “Follow me”. Subscriber B does not take the call in the VoIP network, so the call is rerouted to his mobile telephone.

## Function “SMS at no answer”

In the case of a missed call in the VoIP network, the service mobility extension allows the sending of an information text announcement. This function is called “SMS at no answer” and is described in. In the same way as rerouting of calls, it is possible using the DTMF option to activate and deactivate the service of sending text announcements for missed calls.

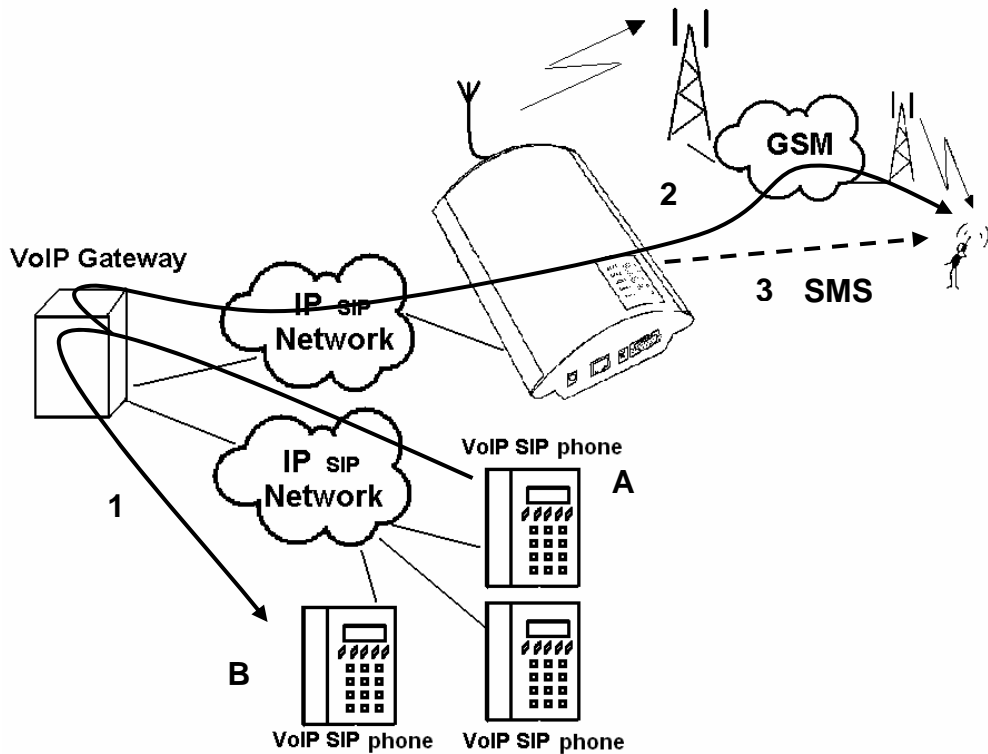

Fig. 20 - Service mobility extension function "SMS at no answer"

Fig. 20 shows the sending of information texts if an incoming call is not taken.. Subscriber A calls subscriber B, who has the permitted service of mobility extension with activated services "Follow me" and "SMS at no answer". Subscriber B does not take the call in the VoIP network, and so the call is rerouted to his mobile telephone. Subscriber B does not take the call even on his mobile telephone, and so he is sent a text announcement telling him that the call from subscriber A had been missed.

### Function of forwarding call

In addition to the rerouting of calls in the event of absence, the function mobility extension allows calls to be forwarded within a VoIP network, which brings the services of the SIP proxy to a mobile telephone. The description of this function is displayed in Fig. 21.

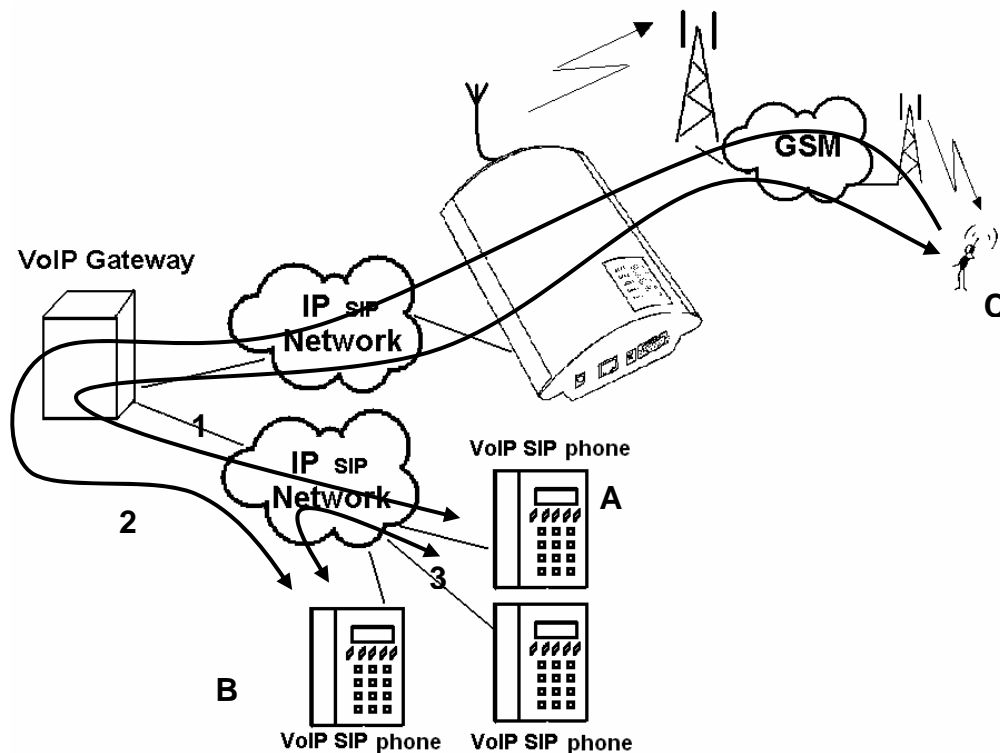

Fig. 21 - Service mobility extension function forwarding call

In Fig. 21 subscriber A is talking to subscriber C, who has the permitted service mobility extension. Subscriber A would like to be forwarded to subscriber B. For this reason subscriber C holds the call with A (in the default setting 7\*), and then calls subscriber B. He tells B that he will forward the call and then forwards the call (in the default setting 7\*). If subscriber B does not want to talk to subscriber A, subscriber C terminates the call with B (in the default setting 9#) and returns to the call with A.

### Function of quick forwarding of call

In Fig.22 subscriber A is talking to subscriber C, who has the permitted service mobility extension. Subscriber A with telephone number 111 would like to be forwarded to subscriber B with telephone number 123. Subscriber C wants to forward the call without having to talk to subscriber B. So subscriber C at first puts the call with A on hold (in the default setting 7\*), and then dials

the quick forwarding character (default value #) and then dials the telephone number of subscriber B. He terminates the selection with the character of end of dialling (default value #). After the VoiceBlue receives the character of the end of selection, it terminates the call between A and C and attempts to make a call between the subscribers A and B. Subscriber A then receives a ring tone.

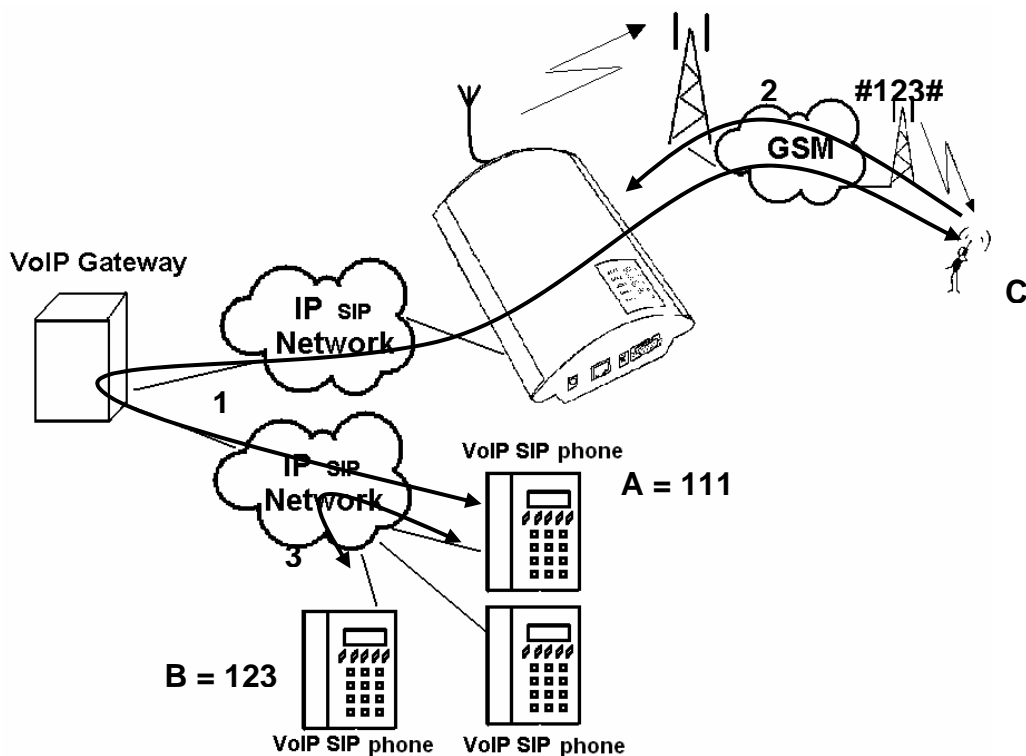

Fig.22 - Service mobility extension function quick forwarding

## 6.4. Recording announcements for mobility extension

Announcements for mobility extension can be recorded using the configuration program (see chapter 9.4) or using AT orders and the protocol X-modem shown below. Announcements of mobility extension are recorded only for subscribers who have this service activated (see chapter). The function mobility extension uses the list of announcements shown in Tab. 4 - list of announcements of service Mobility extension

1.

---

Announcement number	Default file	Designation in configuration programme
MESS1	MESS1 - HELLO.wav	Announcement "Good day"
MESS2	MESS2 - ME.wav	Announcement "Mobile extension"
MESS3	MESS3 - DIAL.wav	Announcement "Dial number"
MESS4	MESS4 - TZ.wav	Announcement "Text announcement"
MESS5	MESS5 - AC.wav	Announcement "Activated"
MESS6	MESS6 - DC.wav	Announcement "Deactivated"
MESS7	MESS7 - HOLD.wav	Announcement "Hold on"
MESS8	MESS8 - BACK.wav	Announcement "Back"

Tab. 4 - list of announcements of service Mobility extension

The format of the recorded announcements must be

Sampling frequency :	8 kHz
Number of bits in sample	8
Audio encoding method:	CCITT A-law
Channels:	Mono
Length of recording:	Max. 4s

## Recording of announcements using terminal and protocol Xmodem

### Recording announcements from PC to VoiceBlue

Run the terminal programme supporting the protocol Xmodem and use it to connect up with VoiceBlue.

- Using the AT order *at!m#=write*, where instead of # fill in the number of the announcement which is meant to be loaded into VoiceBlue. The value "0" is designated for the announcement DISA, the numbers of the other announcements are given in Tab. 4 - list of announcements of service Mobility extension
- . After the insertion of an order you will be called upon to select an audio file which is to be loaded into VoiceBlue.
- Successful loading is announced by the message

### Loading announcements from VoiceBlue to PC

- Run the terminal programme supporting the protocol Xmodem and use it to connect up with VoiceBlue

- Using the AT order *at!m#=read*, where instead of # fill in the number of the announcement which is meant to be loaded into VoiceBlue. The value “0” is designated for the announcement DISA, the numbers of the other announcements are given in Tab. 4.
- After the insertion of an order you will be called upon to select the name of the audio file under which the announcement from VoiceBlue is to be filed.

#### **Deleting of announcements**

You can gain information about a loaded announcements using the AT order *at!m#=view*. To delete an announcement, enter the order *at!m#=erase* in the terminal window, where instead of # fill in the number of the announcement.

## **6.5. Permitting service mobility extension**

As has been stated above, in order for the service mobility extension to be permitted for the individual subscribers it has to be first activated using a licence key. The permitting of mobility extension for subscribers can be performed using the mobility extension table. Its description is given in chapter 9.5. If in this table the CLIP of a mobile subscriber and his url is not given, this function is not permitted for the subscriber.

---

# 7

## SECTION 7

---

### **2N VoiceBlue Lite Routing Rules**

This section explains how to set the call routing rules to make the most of the gateway potential and minimise your telephone costs.

This section includes:

- Functions Supported by 2N VoiceBlue Lite
- Call Routing Rules
- LCR table
- Call Routing to GSM via VoiceBlue Lite
- Incoming calls from GSM to VoIP network
- DISA Message



## 7.1. Functions Supported by 2N VoiceBlue Lite

- Call routing according to time and called destination through the destination's operator;
- Call re-routing;
- Intelligent incoming CLIP routing (CLIP-based call routing);
- Outgoing call routing by time LCR (Least Cost Routing);
- DISA (tone dial-in);
- CallBack to GSM;
- Dial-in to the operator;
- SMS sending/receiving;

## 7.2. Call Routing Rules

Calls from a VoIP port to a GSM network are routed according to the LCR (Least Cost Routing) table to an arbitrary GSM port. If an outgoing call is routed via a port that is busy, the remaining available ports are searched for (depending on the configuration) and if no allowed outgoing port is free, the outgoing call is rejected.

The routing algorithm routes outgoing calls according to the outgoing call type, current time rate, day in a week, and GSM provider's free minutes if any.

Incoming calls from a GSM network are routed directly to the defined SIP address, or the DISA function is enabled. The CLIP function can be used too.

## 7.3. LCR table

The LCR (Least Cost Routing) table is the key telephone cost cutting factor. It helps you set the call routing rules according to the CLIP, daytime and day in a week. By entering public holidays into the LCR table you achieve even more remarkable cuts.

To make call routing to external ports based on prefixes and the LCR table work properly, define the prefix and the total count of digits to be dialled into GSM in the *Network list*. The SIM card inserted in the GSM gateway must be compatible with the defined

---

group. To assign a group to outgoing and incoming calls use the *GSM groups assignment* table.

During call establishing, the LCR table is checked line by line from top to bottom. If the called destination prefix matches the network prefix included in the *Network list* (called *Network ID* in the LCR table), the call is routed according to the routing group (*Groups* in the LCR table) as set in *GSM outgoing groups*. The call is connected via the GSM module assigned to the *GSM outgoing group* in the *GSM groups assignment* table.

If the selected GSM module is busy, another routing rule included in the *Groups* menu and defined by *GSM outgoing groups* is used. Again, an outgoing GSM group is assigned to the GSM module in the *GSM groups assignment* table.

The LCR line is processed in the above-mentioned way until a free GSM module is found. If no suitable GSM module is found (*GSM outgoing group*), the call is rejected.

## 7.4. Call Routing to GSM via VoiceBlue Lite

The outgoing GSM call routing algorithm starts the moment the SIP Proxy routes an outgoing call to VoiceBlue Lite.

Outgoing calls are routed via VoiceBlue Lite as follows:

- The calling subscriber dials a number that is routed to VoiceBlue Lite by the SIP Proxy. It depends on your SIP Proxy configuration whether or not outgoing GSM calls are routed to VoiceBlue Lite.
- The dialled prefix is first compared with the prefixes included on the first line of the LCR table. If no match is found, the following line is used for comparison.
- If the prefix matches a LCR prefix, the call time is checked for match with the routing rule on the line. Again, if no match is found, the following LCR table line is searched.
- In case the prefix and call time comply with the routing rules, the call is routed according to the first routing rule included in *Groups* and *GSM outgoing groups* to the module defined in *GSM groups assignment*.

- If the selected GSM module is busy or has an insufficient credit, the preceding step is repeated for the following line of the *Groups* section. If there is no record, the next LCR table line is searched.
- In case the selected GSM module is free and has a sufficiently high credit, the GSM gateway starts dialling the GSM number.
- If the calling subscriber number has an unknown prefix, or all routes are busy, the GSM gateway rejects the call request.
- An outgoing call is not billed until the called party answers the call.
- The GSM network signals the off-hook and the GSM gateway transfers this information to the SIP Proxy.
- You can enable transmission of a connecting tone\* for outgoing GSM calls, which replaces the silent moment between the request sending and ringing tone.

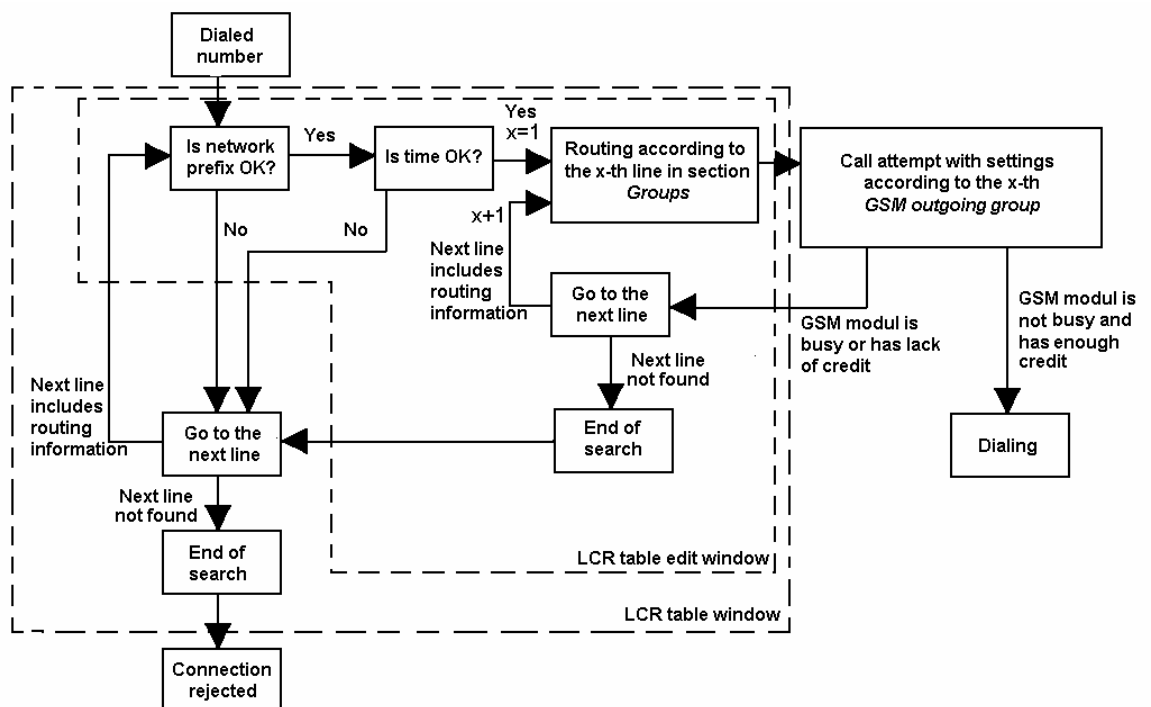

Fig. 23 – Routing of Outgoing GSM Calls

\* This possibility is for TC35i modules only

---

## 7.5. Incoming calls from GSM to VoIP network

Incoming calls from the GSM network are subjected to the algorithm described in Fig. 24 and the following steps:

An incoming call is handled depending on how the parameter “*Mode*” is set in the table “*GSM incoming groups*”. Here it is possible to set several possibilities:

- *Reject / Ignore of incoming calls* – incoming calls will not be routed to the VoIP network. On the side of the GSM network a request for connection can either be rejected or ignored (the caller ringing tone)
- *Report to PC* – information about an incoming call is sent to a PC with a servicing program. The caller is then played an announcement or dial tone. The servicing program then ensures the remaining routing of the call.
- If none of the above possibilities is set, an enquiry is made as to whether the function *Callback* is activated. If for incoming calls the function *Callback* is activated, the callback table is searched. If the callback function is not permitted for the given CLIP (CLIP is not contained in the table *Callback*), the call is either refused or ignored depending on the setting in the menu *GSM incoming groups*. If the table does contain the CLIP, VoiceBlue waits for the end of the call from the GSM subscriber and then calls back to the subscriber in the GSM network.
- If the function *Callback* is not active or callback has already been performed, a test is conducted for the permission of the service *Mobility extension*.
- If the service *Mobility extension* is permitted, the caller is played the list of announcements *Mess 1*, *Mess 2* and *Mess3* (see chapter 6.4). The subscriber may then either activate or deactivate the function “*Follow me*” and “*SMS at no answer*” or transfer the selection to the subscriber in the VoIP network. After the connecting of a call it is possible, as a result of the function, to hold the call, forward it or terminate it as described in chapter 6.3.

- If the service mobility extension is not permitted, the table of *CLIP routings* is searched. This contains records such as AutoCLIP routing and DynamicCLIP routing. If in the table the record AutoCLIP routing is found for the CLIP of the caller, the caller is directly routed to the branch the number of which is entered in the field autodial (see chapter 9.5). If the function AutoCLIP routing is not activated, or if the number of the caller is not included in the table of AutoCLIP routing, the handling of the incoming call continues with a search of the table DynamicCLIP routing. If the number of the caller is found in this table, the incoming call is directly routed to the corresponding branch. The function DynamicCLIP routing can be set in the menu GSM incoming groups (see chapter.9.5).
- If even after this the incoming call is not dealt with, the gate takes the call and either plays an announcement or dial tone to the caller. Then VoiceBlue Lite waits for the required number of numerals necessary for the making of a connection. The minimum and maximum number of numerals of the DTMF selection can be set in the menu GSM incoming calls.
- If VoiceBlue Lite does not receive the minimum required number of numerals, and by the time designated by the parameter Delay when entering DTMF numerals further numerals do not come from GSM, the call is rerouted to the operator in the same way as when the number of the branch called by the caller is not known.
- If the function of routing to the operator is not active, the incoming call is refused.

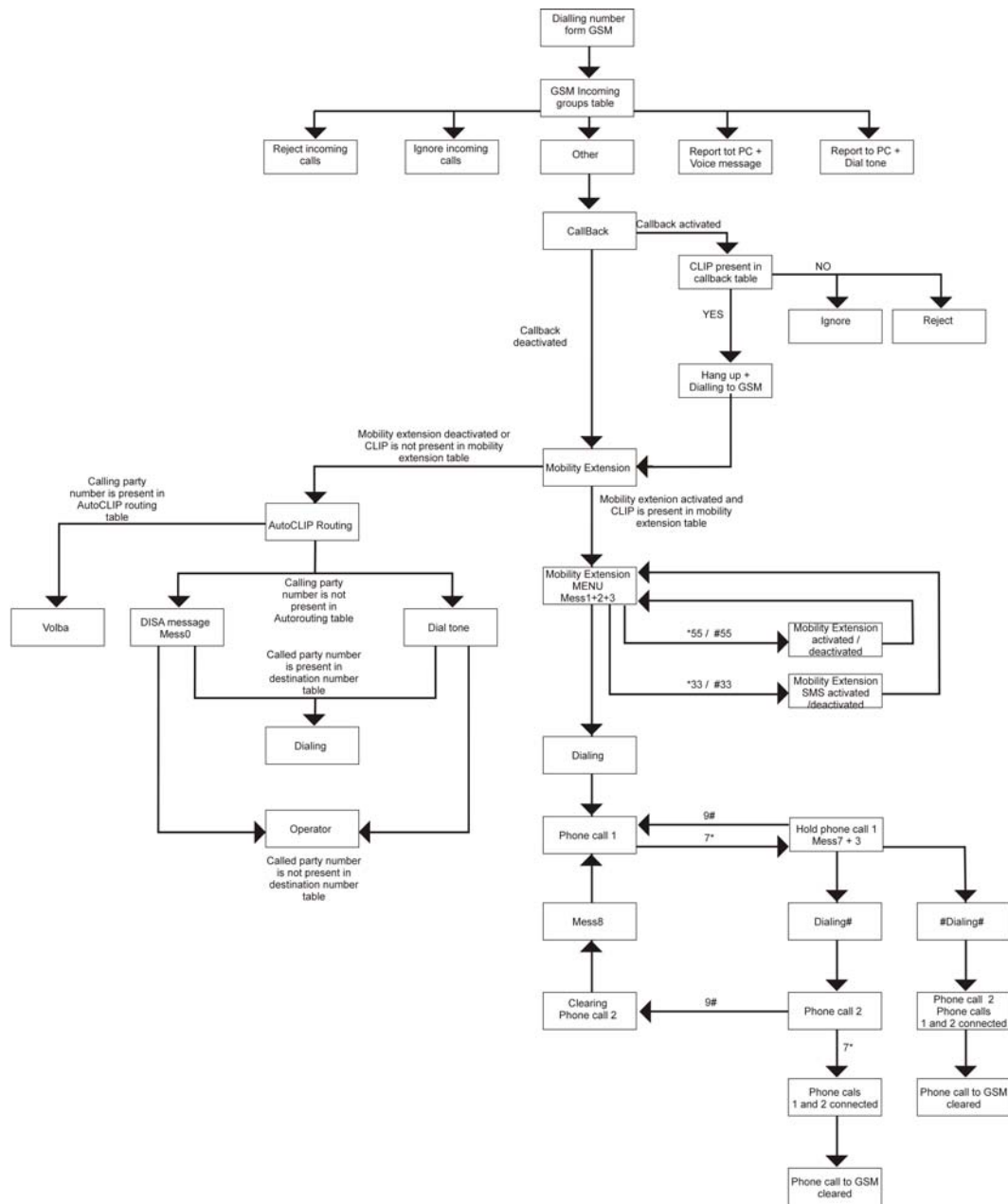

Fig. 24 – Incoming Call Processing Procedure

## 7.6. DISA Message

If the DISA function is enabled and a welcome message recorded, this voice message is replayed to every incoming call whose number is not included in the CLIP routing table or dynamic CLIP routing table. After the message is replayed, the gateway waits for the first DTMF digit for a timeout defined in the *GSM incoming groups – Tout for entering DTMF digits* table. Having received the count of digits defined in *GSM incoming groups – Min. digits in DTMF*, the gateway activates the SIP Proxy connection. For more details on the gateway configuration refer to Subs. 9.5.

It is possible to program the DISA voice message into the gateway by following ways:

- Record DISA using configuration program (see. sub. 9.4)
- Record DISA using terminal and GSM phone

### DISA Message Recording Using Terminal and GSM Phone

#### Recording of DISA message

Open terminal window (see Subs 11).

- Establish connection with your GSM phone using AT command: *at!sg0=phone\_number\_of\_your\_GSM\_phone*
- Accept incoming call from your GSM gateway by GSM phone. (CLIP of SIM card plugged in SIM card holder 1)
- Enter AT command *at!m0=record* in terminal window which results in recording of DISA message (65 s max)
- To stop recording of DISA message press <ENTER>
- Finish the phone call by hanging up or entering of AT command *at!d*

#### Erasing of DISA Message

To get an information on recorded DISA Message enter AT command *at!m0=status*. To erase DISA message enter AT command *at!m0=erase* in terminal window.

---

## Recording DISA using terminal and protocol Xmodem

### Recording DISA announcement

Run the terminal programme supporting the protocol Xmodem and use it to connect up with VoiceBlue.

- Using the AT order *at!m#=write*, where instead of # fill in the number of the announcement which is meant to be loaded into VoiceBlue. The value “0” is designated for the announcement DISA, the numbers of the other announcements are given in chapter 6.4.
- After the insertion of an order you will be called upon to select an audio file which is to be loaded into VoiceBlue.
- Successful loading is announced by a message

### Loading DISA announcement

- Run the terminal programme supporting the protocol Xmodem and use it to connect up with VoiceBlue
- Using the AT order *at!m#=read*, where instead of # fill in the number of the announcement which is meant to be loaded into VoiceBlue. The value “0” is designated for the announcement DISA, the numbers of the other announcements are given in chapter 6.4.
- After the insertion of an order you will be called upon to select the name of the audio file under which the announcement from VoiceBlue is to be filed.

### Deleting DISA announcements

You can gain information about a loaded DISA announcement using the AT order *at!m0=view*. To delete a DISA announcement, enter the order *at!m0=erase* in the terminal window.





---

# 8

## SECTION 8

---

### **Introduction of Configuration Program**

This section introduces the 2N – VoiceBlue Lite configuration software, which is part of the installation CD supplied together with the gateway.

Here is what you can find in this section:

- VoiceBlue Lite Configuration Program Installation
- VoiceBlue Lite Configuration Program Running
- Configuration Program Basic

## 8.1. VoiceBlue Lite Configuration Program Installation

Your 2N - VoiceBlue Lite delivery includes a VoiceBlue Lite installation CD. By inserting this CD in your CD-ROM drive you get an introductory page with a survey of 2N products. Select VoiceBlue Lite and then, in a new window, VoiceBlue Lite installation. An easy installer helps you install the software. Wait until the installation has been completed. The guides and autoupdate program are installed together with the VoiceBlue Lite software.

## 8.2. VoiceBlue Lite Configuration Program Running

When the installation has been completed, run the program by clicking on *VoiceBlue Lite control program* in your PC software menu, or clicking on the desktop icon, or opening the *VBcp.exe* file that you will find in the respective location installed by you using any explorer or file browser.

After starting the configuration program the configuration window shown on Fig. 25 shows up.

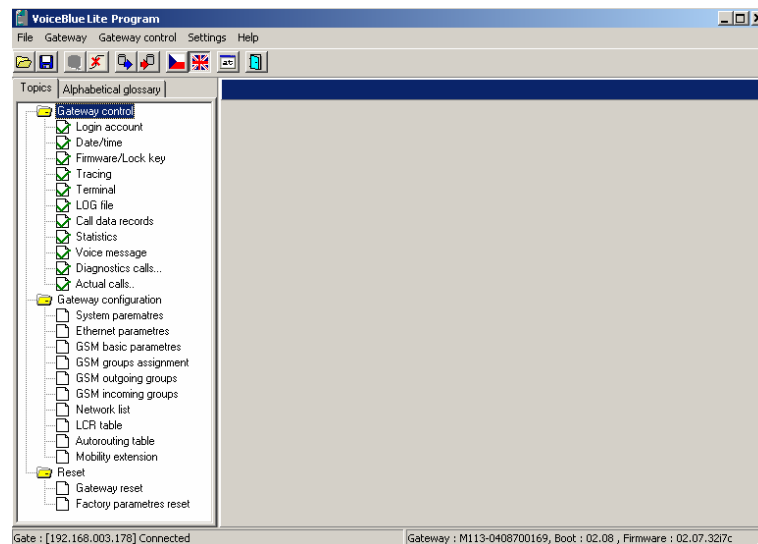

Fig. 25 - Main window of configuration program

To facilitate the administration of more than one 2N – VoiceBlue Lite gateway it is possible to use Gateway selection window. For

---

taking advantage of this function start by editing of new gateway in *Gateway list* menu (ALT+F4)



Fig. 26 - Gateway list selection

After selecting of *Gateway list* the window Gateway selection window shown on Fig. 27 shows up.

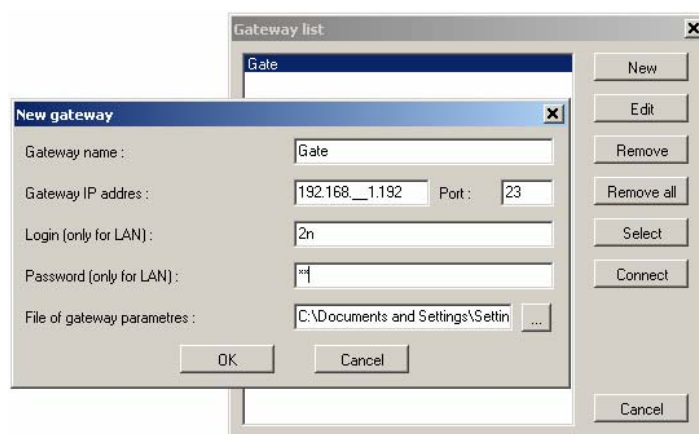

Fig. 27 - Adding of new entry to gateway list

- *New* - click on *Add* to open a window with some essential data necessary for the gateway identification (see Fig. 27). Enter the gateway name and complete the *Gateway IP address*. To get the LAN connection, enter your *Username* and *Password*. You need not complete these items if you control the GSM gateway by the USB. Finally, complete the *File of gateway parameters* including the directory path and filename. New entry is added to the gateway list after clicking the "OK" button.
- *Edit* – used for editing identification data on the gateway entered. To edit the data, select the required gateway from the list of used gateways and click on *Edit*.
- *Remove* – used for removing a gateway from the list of used gateways.

- *Remove all* - used for removing all gateways from the list of used gateways.
- *Select* – click on this button to select a GSM gateway whose parameters can be set after *Close* is pressed.
- *Connect* – by clicking on this button the VoiceBlue Lite program attempts to connect to the gateway according to the setting in “Settings -> Communication settings..” configuration. If the communication type was not selected, the program starts to scan COM ports in order to find connected gateway.
- *Close* – used for closing the *Gateway selection* window and opening the gateway configuration window.

---

### 8.3. Configuration Program Basic menu

The following items are available in the main configuration program menu:

- *File* – for physical work with the configuration file
- *Gateway* – for selecting of the gateway from gateways list and interconnecting it with VoiceBlue program.
- *Gateway control* – contains function for online configuration a diagnostic of the gateway
- *Settings* – menu items for *Communication settings* and *Language setting* of the configuration software.
- *Help* – information on the *About application* of the configuration software together with contacts to the technical support personnel.

#### File

This menu is accessible under (Alt + f).

- *Load* – is used for loading of the configuration file of the selected gateway to the configuration program.
- *Save* – is used for saving of the configuration to the configuration file of the selected gateway.
- *Load from disk* – is used for loading an external file to the configuration program. Structure of this file is same as of configuration file which was selected on gateway selection procedure, but he content is different
- *Save as* – is used for saving of configuration to an external file than the one selected on gateway selection procedure.
- *Default settings* – sets all parameters to default values.
- *Close* - terminates the configuration program work.

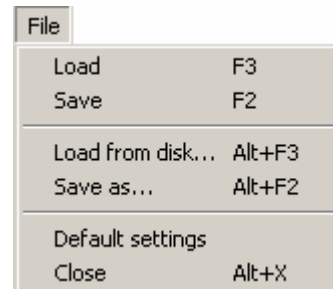

File	
Load	F3
Save	F2
Load from disk...	Alt+F3
Save as...	Alt+F2
Default settings	
Close	Alt+X

## Gateway control

This menu is available under (Alt + a). Configuration is possible with connected gateway only. If the gateway is not connected the program attempts to establish connection by itself. All items of this menu are described in section 9.4.

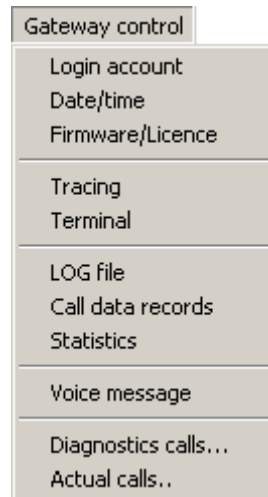
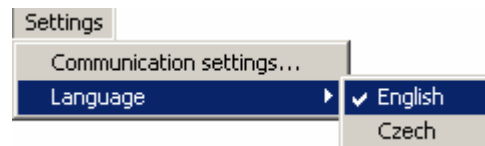

Fig. 28 - gateway control menu

## Settings

This menu is available under (Alt + s).



- *Communication setting* - helps set the type of communication of the 2N – VoiceBlue Lite gateway configuration software. By clicking on this item you open a configuration window (see Fig. 29). You can use a serial ro USB cable, LAN or Internet for communication with the GSM gateway.

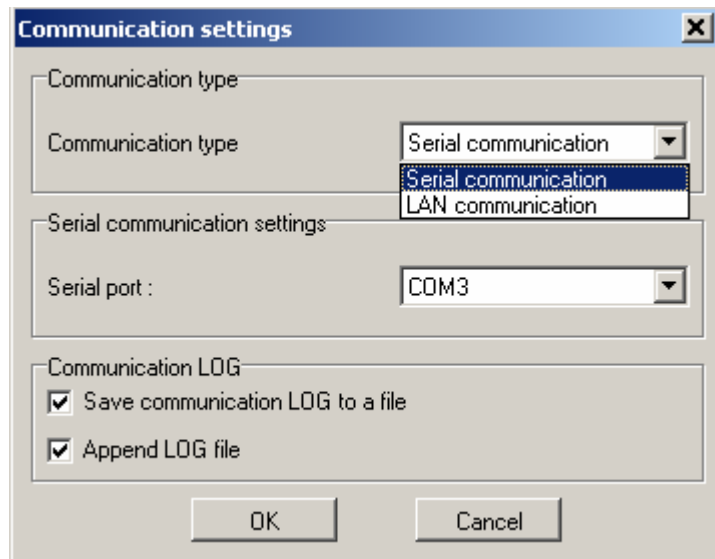

Fig. 29 – Communication Setting Window

*Types of communication:*

*Serial communication* - used for GSM gateway configuration from your PC using a serial or USB cable. The serial communication mode is suitable for the initial setup. USB communication is suitable for detailed tracing of the gateway. The configuration program offers available COM ports.

*TCP/IP* – used for GSM gateway configuration via the Internet or LAN. Be sure to set the correct gateway IP address before configuring. For the IP address setting refer to Subs. 8.2.

*LOG communication:*

You can set whether and how the PC - GSM gateway communication should be saved into a file.

By clicking the “OK” button the gateway attempts to connect to the gateway according to communication settings.

- *Application language* - sets the language used for tag names.



## Help

This menu is available under (Alt + h).

- *About* - opens a window providing information on the configuration software version together with contacts to the technical support personnel.

## 8.4. Button Bar

The button bar (Fig. 30) displays the most frequently used commands that make the work with the GSM gateway easier and quicker.

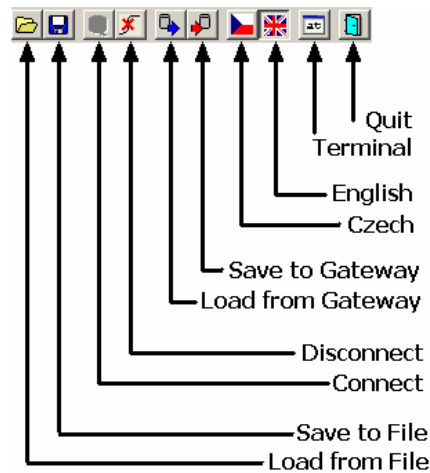

Fig. 30 – GSM Configuration Program Button Bar

## 8.5. Topic List and Alphabetical Glossary

Select the more convenient of the two arrangements of configuration program items (Fig. 31). The sections below are arranged according to the *Topic list*.

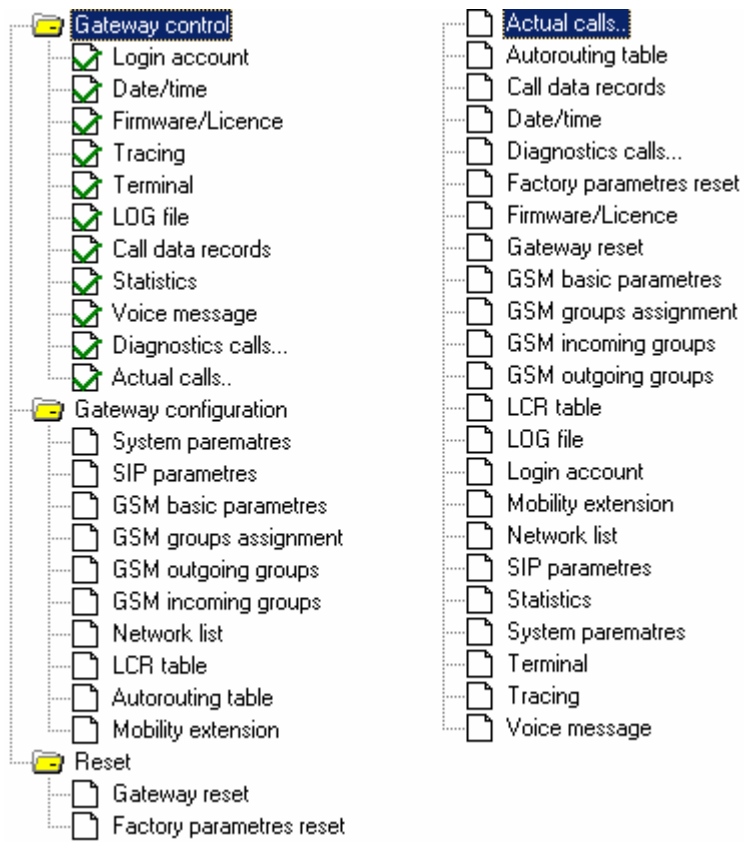

Fig. 31 – Topic List (left) and Alphabetical Glossary (right)



---

# 9

## SECTION 9

---

### **Configuration**

This section describes the 2N - VoiceBlue Lite gateway setting using the VoiceBlue Lite configuration software that is part of the installation CD supplied together with the gateway.

Here what you can find in this section:

- Establishing Communication with VoiceBlue Lite
- Firmware Identification and Upgrade
- Gateway Licencing
- Gateway control Items
- Gateway configuration
- Reset

## 9.1. Establishing Communication with VoiceBlue Lite

The communication establishing procedure is summed up in the two steps mentioned below, *Gateway selection* and *Communication setting*.

### Gateway selection

Select “*Gateway -> Gateway list (ALT + F4)*” in the *Main menu* of the configuration program. From the list of gateways select gateway to be configured (refer to Subs. 8.2).

### Communication setting

In the *Main panel* select “*Settings -> Communication setting*” and the type of gateway connection.

Use the *Communication setting* window to select the type of configuration program communication with 2N - VoiceBlue Lite. This selection opens a configuration window (see Fig. 32). You can use a serial cable, USB cable, the LAN or Internet for communication with VoiceBlue Lite.

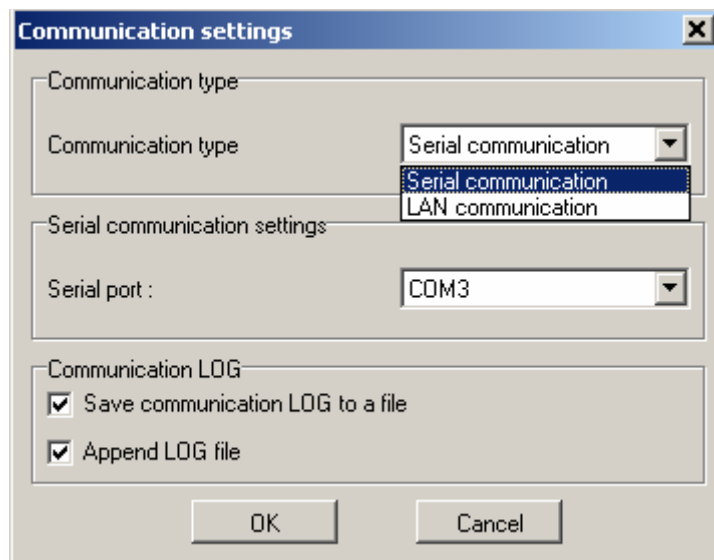

Fig. 32 – Communication Setting Window

---

*Types of communication:*

*Serial communication* - used for GSM gateway configuration from your PC using a serial or USB cable. The serial communication mode is suitable for the initial setup of the gateway and detailed tracing. Configuration program offers unused COM ports only.

*LAN communication* – used for GSM gateway configuration via the Internet or LAN. Be sure to set the IP address of the gateway you want to communicate with before configuration. For the IP address setting procedure refer to Subs. 8.2. Set the *Time to wait for response [ms]* for network communication. The default value of this parameter is 5,000 ms.

*Communication LOG:*

In this section is possible to set whether and how the PC - GSM gateway communication should be saved into a file.

Click on *OK* to establish connection between your PC and the GSM gateway.

## **9.2. Firmware Identification and Upgrade**

If you connect the GSM gateway for the first time, please identify the current firmware version by clicking on “*Gateway control -> Firmware/Licence*”. The *Firmware/Licence* item offers two sections. The *Firmware* section (see Fig. 33) helps identify the current firmware version and upload a new firmware version from a PC to the gateway. The *Licence* section enables to unlock the GSM gateway (refer to Subs. 9.3).

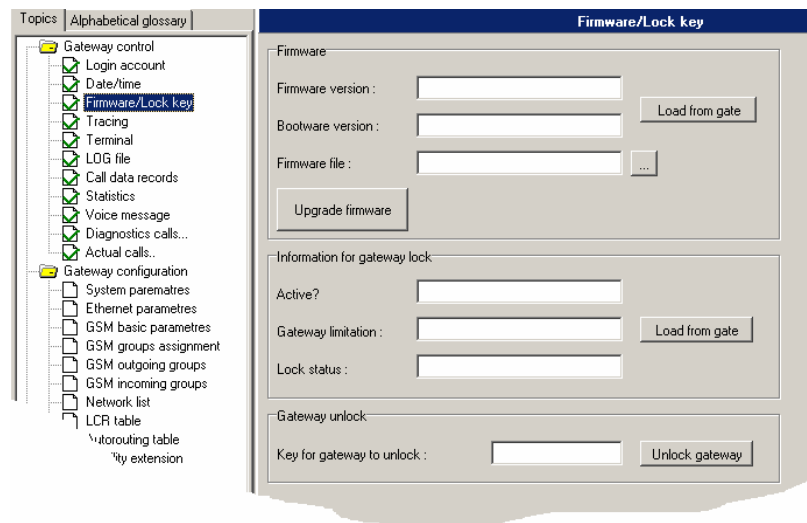



Fig. 33 – Firmware Window

To identify the current firmware version click on *Load from the gate*. Compare the firmware version of your VoiceBlue Lite with the version available on our websites ([www.2n.cz](http://www.2n.cz)).

If your GSM gateway firmware version is older than that distributed by us, upload the latest firmware version to your GSM gateway. Please follow the instructions mentioned below.

Since the product is subject to innovations, please check the latest firmware version on our websites regularly ([www.2n.cz](http://www.2n.cz)).

## Firmware uploading

- Establish communication with the gateway (refer to Subs.9.1).
- Click on  and find a firmware file in your PC named P2008-V-\*.hex. Click on *Open* to get the file ready for uploading into 2N - VoiceBlue Lite.
- Click on  to start the firmware uploading process.
- The program starts uploading the firmware into VoiceBlue Lite automatically. The gateway is in the reset mode during the process. **Do not interrupt the firmware uploading process** to avoid firmware damage and gateway failure.

- 
- Should the firmware uploading process get interrupted, reset the GSM gateway and re-try to upload the firmware.
  - After successful upload of the firmware, please make factory reset of the gateway.
  - **CAUTION!** Make sure that what you are going to upload is the original and undamaged file with the latest firmware version as available at our websites ([www.2n.cz](http://www.2n.cz)).

### 9.3. Gateway Licencing

The operation of every new 2N - VoiceBlue Lite gateway is limited to **850 hours**. Every gateway reset reduces the remaining gateway operation time by one hour. To identify the GSM gateway status, click on “*Gateway control -> Firmware/Licence*” in main menu of the configuration program. The *Firmware/Licence* item offers two sections. The *Firmware* section helps identify the current firmware version and upload a new firmware version from a PC to the gateway (refer to Subs.9.2). The *Licence* section enables to licence the GSM gateway (see Fig. 33). **Please contact our technical support personnel to get the key.**

Enter the received key into *Licence for the gateway unlock* and press *Set gateway licence*. To find whether your gateway has been unlocked successfully, press *Load from the gate*.

**WARNING!** By inserting an invalid key you make the GSM gateway fail.



## 9.4. Gateway control Items

The items are active only if the VoiceBlue Lite gateway is connected.

### Login account

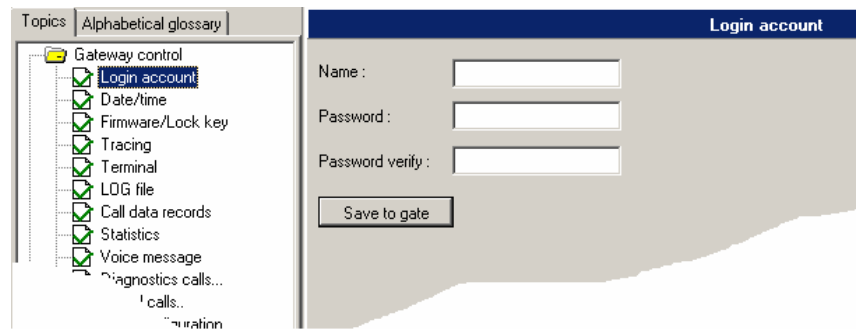

Fig. 34 – Login Account Window

Using this item you can change the *Username* and *Password* that are required by VoiceBlue Lite for remote configuration via the Telnet protocol. These login parameters may not be changed completely for safety reasons if you are connected to the gateway using the Telnet protocol. In default are

- *Name:* 2n
- *Password:* 2n

### Date/Time

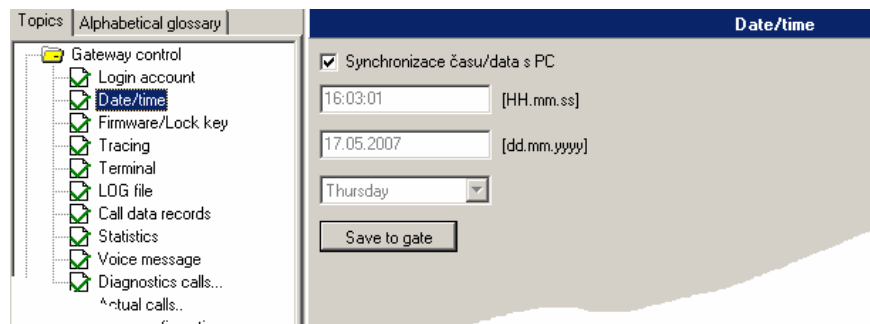

Fig. 35 – Date and Time Setting Window

---

This is an item for synchronisation of the system time and connected VoiceBlue Lite gateway with your PC. To set another date in your gateway, tick off the *Synchronise date/time with PC* item and set the value manually.

## **Firmware / Licence**

*Firmware* - use this menu to find the firmware and bootware versions that are currently available in the gateway. Moreover, you can upload a new firmware version into the gateway with this item. For more details refer to Subs. 9.2.

*Licence* - if your VoiceBlue Lite gateway has been blocked for a certain number of hours, this item helps you send a key that you have received from the 2N technical support personnel to unlock the gateway.

**WARNING!** By inserting an invalid key you make the GSM gateway fail! For details refer to Subs. 9.3.

## **Tracing**

This item is used for analysis of the GSM gateway behaviour on each RM OSI model layer. You can assign time stamps to the records for easier orientation in listings. It is possible to automatically record listings into a file and, if necessary, sent to the 2N technical support department. If a detailed VoIP-SIP trace is required, we recommend you to connect VoiceBlue Lite using a serial or USB cable. This type of connection allows for a detailed data transmission in every SIP report.

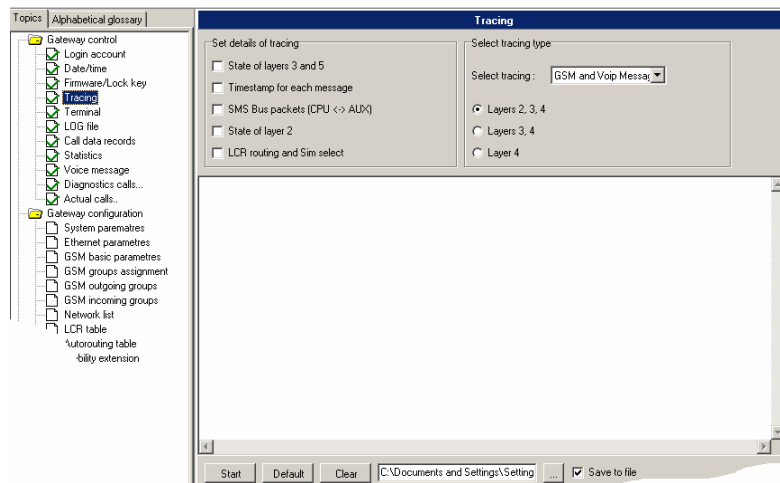

Fig. 36 – Tracing Window

## Terminal

The internal terminal of the VoiceBlue Lite control software is displayed here. This window enables you to communicate with the VoiceBlue Lite gateway directly using AT commands as mentioned in Subs. 11.6.

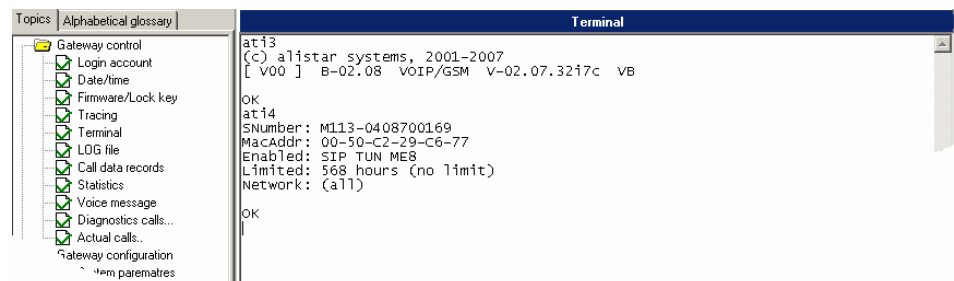

Fig. 37 – Window of Terminal Integrated in Configuration Program

## LOG file

Used for reading and, if required, saving of LOG information from the connected VoiceBlue Lite gateway. For description of records refer to Subs. 11.7.

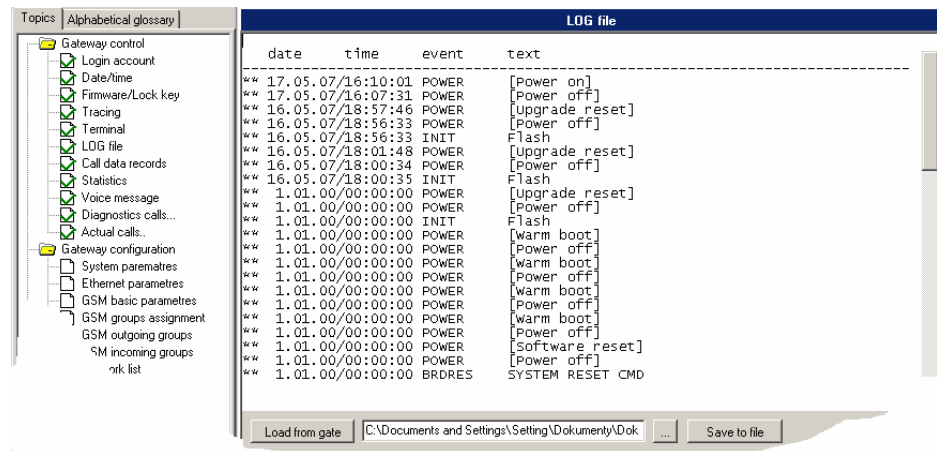

Fig. 38 - Log window

## Record on calls

Reading and saving of records on calls from the connected VoiceBlue Lite gateway.

## Statistics

VoiceBlue Lite automatically generates detailed statistics on all outgoing and incoming calls. Statistical data can be displayed, saved or reset using this item.

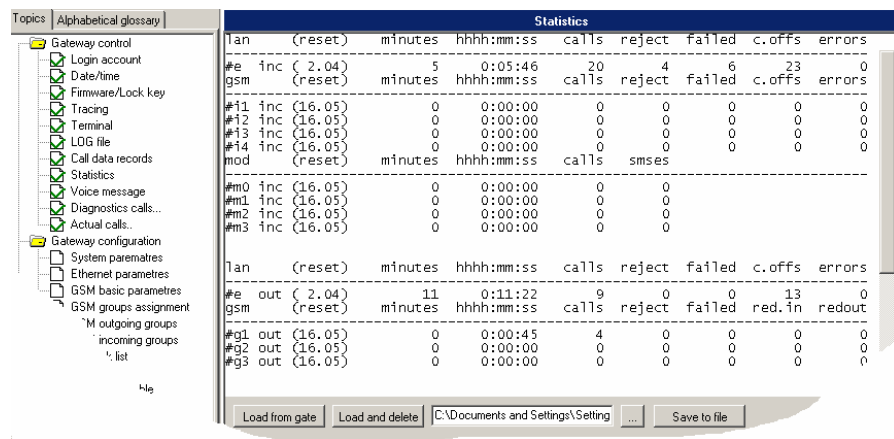

Fig. 39 - Statistics window

## Voice message

Used for reading and writing of voice messages to the VoiceBlue Lite gateway. This window is separated in to sections. The “*Read / Write message using COM*” is intended for upload and download of voice messages via the protocol X-modem

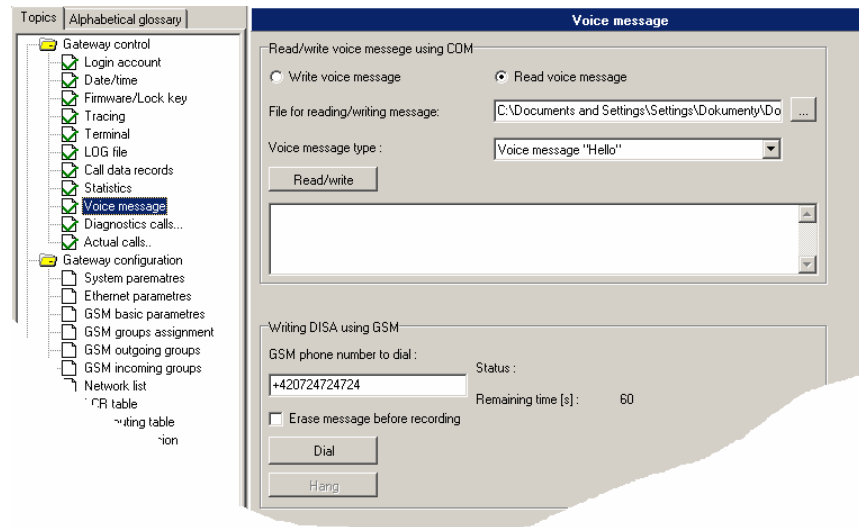

Fig. 40 – Voice Message Recording Guide

- *Write voice message* – performed after pressing button *Read/Write* recording of message to VoiceBlue
- *Read voice message* – performed after pressing button *Read/Write* download of message to VoiceBlue
- *File for reading/writing message* – selection of name of file which is to be loaded into VoiceBlue.

### Voice message parameters

Sampling frequency:	8 kHz
Number of bits in sample	8
Audio encoding method:	CCITT A-law
Channels:	Mono
Length of recording:	Max. 4s

- *Voice message type*:– selection of type of message which is to be loaded into VoiceBlue. Before loading the voice message, please check whether the message parameters correspond to the requirements placed on this message.

---

The section “*Writing DISA using GSM*” is intended for recording DISA message using the GSM phone.

- *GSM number to be dialled* – either the phone number of your GSM phone
- *Erase message before recording* – Ensures erasing of the voice message before dialling to GSM network
- *Dial* – clicking this button starts dialling to the GSM network via GSM module 0.
- *Hang up*- Hangs up the call to GSM and stops recording of the DISA message.

## GSM diagnostic

Select this item to display information on the GSM modules and SIM cards inserted in the gateway.

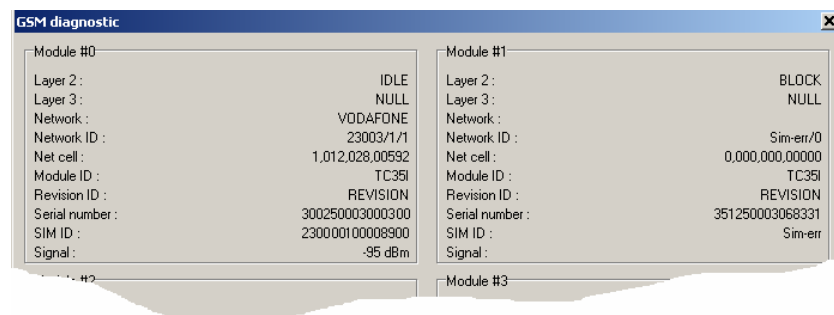

Fig. 41 – Diagnostics

- *Layers 2 and 3* – GSM module status on communication layers 2 and 3.
- *GSM Network* – name of the GSM network to which the GSM module has logged.
- *Network ID* – network MCC+MNC / GSM outgoing group number / GSM incoming group number. This parameter also specifies the cause of a GSM channel error if any.
- *GSM cell* – identifies the cell to which the GSM module has logged.

Description of displayed numbers:

Network cell: A,BBB,CCC,DDDDD

A = status:

- 0 – not registered
- 1 – registered in home network
- 2 – not registered, but the GSM module is searching for a new provider
- 3 – registration barred
- 4 – unknown status
- 5 – registered in roaming network

BBB = first LAC byte (location area code) in decadic format

CCC = second LAC byte in decadic format

DDDDD = cell ID

- *Module ID* – GSM module type
- *Revision ID* – GSM module version
- *Serial number* – GSM module IMEI

*SIM ID* – SIM card IMSI or SCID

## Actual calls

Select this item to display information on currently made calls.

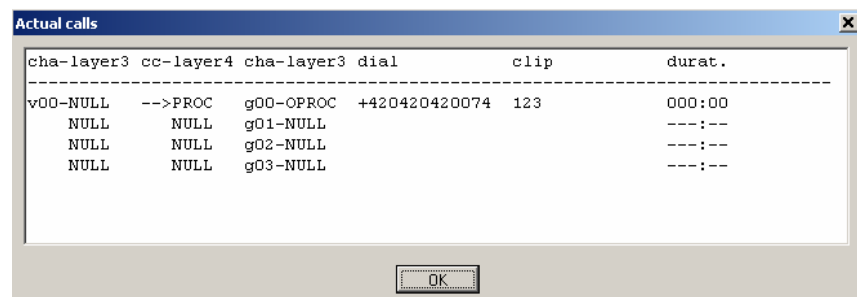

Fig. 42 – Call Information Displaying Window

## 9.5. Gateway configuration

Here you can modify the VoiceBlue Lite configuration even if the VoiceBlue Lite gateway is not connected. All settings are stored into a configuration file set during your gateway selection (refer to Subs. 8.2).

---

## System parameters

System parametres	
IP address :	
IP address :	192.168.3.178
Subnet mask :	255.255.252.0
IP router :	192.168.1.5
Modes :	
CDR mode :	None
Unit ID :	0
(0 = off, 255 = max)	
PIN :	1234
End of dialing (Empty=off) :	#
Mobility Extension (DTMF settings) :	
Start dialing (quick call forwarding) :	#
"Follow me" activation :	55
End dialing (quick call forwarding) :	#
"Follow me" deactivation :	#55
Hold call :	7*
"SMS at no answer" activation :	33
Hang up call :	9#
"SMS at no answer" deactivation :	#33
Save to the gate Load from the gate Default Save to file	

Fig. 43 – System Parameters Window

This configuration window has three subgroups. The following parameters to be configured are explained according to these subgroups.

- *IP setting*
  - *IP address* – set the IP address to be assigned to VoiceBlue Lite;
  - *Subnet mask* – set the subnetwork mask;
  - *IP router* – set the IP address of the gateway that VoiceBlue Lite uses for connection with another network.
- *Modes*
  - *CDR mode* – the CDR (Call Detail Report) helps record data on calls. Select on which calls and whether data should be recorded in a pull-down menu.
  - *Unit ID* – used for VoiceBlue Lite identification in case in case there are more devices in the network that generate the CDR.



- *PIN* – enter the PIN code to be entered for new SIM cards automatically. The PIN codes of once inserted SIM cards are remembered.
- *End of dialling* – enter the character to be used as end of dialling to VoIP network.
- *Mobility extension (DTMF settings)* – this section defines the functional keys of the service mobility extension. **We recommend that the fields in this section be left at their default values**
  - *Start dialling (quick call forwarding)* – serves to define the DTMF numerals of the attribute which will be allocated to the telephone number to which the calls should be rerouted during quick call forwarding (see chapter 6.3)
  - *End of dialling (quick call forwarding)* – serves to define the DTMF numerals of the attribute which will mark the end of dialling (see chapter 6.3)
  - *Hold call* – this combination of DTMF numerals allows the mobile subscriber to put the call in the HOLD mode.
  - *Hang up call* - this combination of DTMF numerals allows the mobile subscriber to switch the call from the HOLD mode to the call mode or end an ongoing call.
  - *“Follow me” activation* – combination of DTMF selection for activating the rerouting of call to the GSM network if the participant in the VoIP network is not available (see Fig. 19)
  - *“Follow me” deactivation* – combination of DTMF selection for cancelling rerouting of call to GSM network if the participant in the VoIP network is not available (see Fig. 19)
  - *“SMS at no answer” activation* – combination of DTMF selection for activating the sending of a text message when a call is not taken (see Fig. 20)
  - *“SMS at no answer” deactivation* – combination of DTMF selection for cancelling the sending of a text message when a call is not taken (see Fig. 20)

---

## SIP parameters

All VoiceBlue Lite parameters concerning the VoIP network are set in this configuration menu. For the configuration window see Fig. 44.

The screenshot shows the 'SIP parameters' configuration window. It is divided into several sections:

- Mode/protocol:** SIP (selected in a dropdown).
- Day of deleting statistics:** 0 (with a note '(0=off)').
- Voice parameters:** First RTP port: 8000, Last RTP port: 8998. A note states: '(1st RTP port must be higher than 1024 and 2nd port must be higher or equal by 10 than 1st port)'. There are also checkboxes for G711, G723, and G729 under 'Codecs settings' and a 'G723 bitrate' dropdown set to 6.3 kbps.
- SIP registration:** Registration expires: 300 [s], Reattempt registration: 10, Registration domain (realm): 192.168.2.208, Name: 178, Username: (empty), Password: (empty).
- Codecs priority:** Select supported codec: G729 (selected with a radio button). Priority 1: 18 - G72, Priority 2: 8 - G711, Priority 3: 0 - G711.
- SIP protocol settings:** Four checkboxes: 'Send 180 Ringing instead of 183 Session progress' (unchecked), 'Send 200 OK instead of 180/183' (unchecked), 'Send 486 when refused from GSM' (unchecked), and 'Replace CLIP from GSM by registration name' (unchecked).
- IP addresses:** SIP proxy (IP->GSM): 192.168.2.208, SIP proxy (GSM->IP): 192.168.2.208, SIP registration: 192.168.2.208, NAT firewall: 0.0.0.0, STUN server: 0.0.0.0, Next STUN server request: 600 [s]. There are also checkboxes for 'Use default port' with values 5061 and 3478.

At the bottom of the window are four buttons: 'Save to the gate', 'Load from the gate', 'Default', and 'Save to file'.

Fig. 44 – Ethernet Parameter Configuring Window

- *Mode/Protocol* – set the signalling protocol type\*.
- *Date of deleting statistics* – a day in a month on which all statistical data on the VoIP interface are deleted automatically.
- *Voice parameters* – set the voice channel parameters:

---

\* Currently only SIP

- *First RTP port* – the first RTP port number. The RTP port number is recommended to be even.
- *Last RTP port* – the last RTP port number. The RTP port number is recommended to be even. The recommended range of RTP port is 10 at least.
- *SIP registration* – set the parameters of VoiceBlue Lite registration at the SIP Proxy;
  - *Registration expires* – the timeout after which the VoiceBlue Lite registration data get expired at the SIP Proxy.
  - *Reattempt registration* – the timeout after which the request is resent.
  - *Registration domain* – If the “*SIP registrar*” field is empty, VoiceBlue Lite registers to the domain set in this field.
  - *Name* – user name
  - *User* – user name for authentication
  - *Password* – Password required for authentication with SIP proxy
- *Codecs priority* – define which speech coding codec types should be preferred. Codecs as recommended by ITU-T G.729, G.711 and G.723.1 might be used (for more details refer to Subs. 5.1).
- *Codecs settings* – sets how many speech blocks shall be coded with the given algorithm at the same time. Coding of a high number of blocks results in a lower resultant transmission rate and a higher voice transmission delay.
- *SIP protocol setting* – used for setting SIP report sending during establishing connection. In this section is possible to set replacement of CLIP from GSM by the *Name* set in the *SIP registration* section.
- *IP addresses* – used for setting IP addresses of interworking network devices and default port numbers through which VoiceBlue Lite will communicate with them.

- *SIP Proxy (GSM->IP)* – the IP address of the SIP Proxy to which VoiceBlue Lite turns in the case of an incoming GSM call.
- *SIP Proxy (IP->GSM)* – the IP address of the SIP Proxy from which VoiceBlue Lite awaits outgoing GSM call requests.
- *SIP registrar* – the IP address of the SIP registration server.
- *NAT firewall* – the NAT firewall IP address.
- *STUN server* – IP address of the STUN server (Simple Traversal of UDP through NAT's (Network Address Translation)), which is used for obtaining of public IP address presented to Internet. It is useful to fill in this field in case the VoiceBlue Lite is present in a private network behind the firewall or NAT. Default port for sending of requests on STUN is 3478.
- *Next STUN server request [s]* – for setup of time period between two requests for public IP address information.

## Basic GSM parameters

The screenshot shows a window titled "GSM basic parameters" with the following fields and controls:

- Call delay [s]: 2
- Min. numbers from VoIP: 9
- Max. numbers from VoIP: 9
- Wait for next digit [s]: 3
- SIM card number: IMSI
- Dail tone: None
- Ring tone: None
- Error GSM causes:
  - Lack of digits in OVERLAP mode: 102
  - Restricted number prefix: 21
  - Selected module/GSM group is not ready: 41
  - No module/GSM group is ready: 42
- Cause transfer: (empty list with Add, Remove, and Remove all buttons)
- Buttons at the bottom: Save to gate, Load from gate, Default, Save to file

Fig. 45 – Basic GSM Parameter Setting Window

- *Call delay* – the time period between the end of the last call and beginning of the next call via one and the same GSM module (all incoming and outgoing calls are rejected during this time). The recommended value is about 2 s - do not change this setting please unless absolutely necessary.
- *Min. numbers from VoIP* – the minimum count of digits dialled into the GSM network.
- *Max. numbers from VoIP* – the maximum expected count of digits dialled into the GSM network.
- *Wait for next digit* – time during which VoiceBlue Lite waits for another digit dialled from the VoIP network to GSM.
- *SIM number* – the SIM Id number to be displayed in the diagnostic window and records on calls.
  - *IMSI* – International Mobile Subscriber Identity
  - *SCID* – SIM Card Identification number
- *Dial tone* - selection of dial tones which will be played to the caller from the GSM network
- *Ring tone* - selection of control ring tones which are to be played to the caller from the GSM network.
- *Error GSM causes* – allows changing of GSM release causes for call control. Individual causes are transferred to SIP message number according the chart in “*Cause transfer -> Add -> ?*” item.
- *Causes transfer* – for GSM call control causes change

---

## GSM groups assignment

Module :	Outgoing :	Incoming :
0. module	1. Group	1. Group
1. module	2. Group	4. Group
2. module	3. Group	3. Group
3. module	4. Group	2. Group

Buttons: Save to gate, Load from gate, Default, Save to file

Fig. 46 – Group Assigning Window

The users communicating through VoiceBlue Lite can be divided into user groups. You can define up to four mutually independent groups of outgoing and incoming calls that may be assigned arbitrarily to the GSM modules.

## GSM outgoing groups

Settings for 1 GSM group:

- Roaming enabled for network:
- CLIR: Factory
- Max. number of called minutes: (0 = off) 0
- SMS messages number: (0 = off) 0
- Day of deleting stats: (0 = off) 1
- Minimal length of call after connect: 1
- Precision of counting length of call: 1
- Pseudo tarif: (0 = off) 0
- Delay for CONNECT [s]: 0
- Delay for ALERTING [s]: (0 = off) 5
- Disconnect call: Never
- Day of deleting stats in group: 1
- Default delay for "SMS at no answer" [s]: (0 = off) 0
- Text of "SMS at no answer":
- Clip to GSM separator: (empty = off)

Buttons: Save to gate, Load from gate, Default, Save to file

Fig. 47 – Outgoing Group Setting Window

The 2N - VoiceBlue Lite gateway allows you to work with four groups of outgoing calls. You can select different settings for each

of them with respect to establishing connections, count of called minutes and sent messages within a period. To set the company parameters use *Default*. The meanings of the card items are as follows:

- *Roaming enabled for network* – an international identification code of the network for which roaming is enabled. It consists of two numbers:
  - MCC – Mobile Country Code (Czech Republic - 230)
  - MNC – Mobile Network Code (T-Mobile 01, Eurotel 02, Oskar 03)

Thus, the T-Mobile International Identification Code in Czech Republic is 23001.

To disable roaming leave this field blank.

- *CLIR* – This parameter defines whether or not the calling SIM card telephone number shall be displayed to the called party. It is not recommended to present the telephone number of the SIM card inserted in the GSM module to the called party to avoid calling back problems. It is impossible for technical reasons to transmit telephone numbers of SIP terminals to a GSM network. One of the following parameters can be set for each GSM group:
  - *Factory* – default settings of the GSM provider.
  - *Disable (CLIP on)* – the SIM card telephone number is transmitted to the GSM network. Contact your GSM provider for activation of this service if it is not supported automatically.
  - *Enable (CLIP off)* – the SIM card telephone number is not transmitted to the GSM network. **CAUTION!** Some GSM providers do not support this function, which might lead to rejection of an outgoing call.
- *Max. number of called minutes* – defines the maximum number of minutes called within a month through the given SIM card. This parameter is ignored if 0 is selected.

- 
- *SMS messages number* – defines the maximum possible number of SMS messages sent within a month from the given SIM card. This parameter is ignored if 0 is selected.
  - *Date of deleting stats* – sets the day in a month on which the statistic data on *Max. number of called minutes* and *SMS messages number* are deleted. This parameter is ignored if 0 is selected.
  - *Minimum length of call after connect* – the length of the first pulse after which pulses are counted according to the value included in the *Precision of counting length of call* parameter.
  - *Precision of counting length of call* – the number of seconds per pulse after the timeout defined in the *Minimum length of call after connection* parameter.

Example:

If, from the viewpoint of the GSM provider, a call shorter than 60s is billed as a 60s call, set the *Minimum call length* at 60s. If the GSM provider bills calls in seconds after the first 60s, set the *Call length measurement accuracy* at 1 s.

- *Pseudo tariff* – makes the GSM gateway generate tariff rate pulses itself. The number defines how many pulses the gateway transmits per minute. The 0 value disables this function.
- *Delay for CONNECT [s]* – a delay before sending information on a connected call after reception from the GSM network.
- *Delay for ALERTING [s]* – a delay before sending information on ringing start.
- *Disconnect call* – the currently made call is disconnected in cases included in a pull-down menu.
- *Date of deleting stats in group* – defines the day on which statistic data on disconnected calls are deleted.



- *Default delay for “SMS at no answer”* – the service SMS at no answer makes it possible to send information text messages to a user to the GSM network who at the time of a call from the VoIP network was not available. The wording of the text message can be edited in the field Text SMS (number = %N). In this field it is possible to designate how long the called party’s telephone should ring before the text message is sent. If the value “0” is set here, this function is not switched on.
- *Text of the “SMS at no answer”* - in this field it is possible to edit the text which will be sent via a text message if the subscriber in the GSM network is unavailable.
- *CLIP to GSM separator* – if not empty, the character separates Called party number and calling party number in the setup message to GSM

Example:

“*CLIP to GSM separator*” = “#”. If the user 999 in VoIP network dials +420123123123 to GSM, the VoiceBlue Lite dials +420123123123#999 to GSM network.

---

## GSM incoming groups

The screenshot shows the 'GSM incoming groups' configuration window. It features a tabbed interface with four tabs labeled '1 GSM group', '2 GSM group', '3 GSM group', and '4 GSM group'. The first tab is active. The 'Mode' dropdown menu is set to 'Reject incoming calls'. Below this, there are several configuration fields: 'Min. digits in DTMF' (3), 'Max. digits in DTMF' (3), 'Time for entering DTMF digits [s]' (10), 'Day of deleting stats' (1, with '(0 = off)' next to it), 'Prefix before DISA' (empty), 'Clip' (+), 'Clip to VoIP separator' (empty, with '(empty = off)' next to it), and 'Time to keep CLIP in table [hours]' (0, with '(0 = off)' next to it). There are two checkboxes: 'Add record only for unconnected call' and 'Delete record for connected answer', both unchecked. A 'List of called numbers' area is empty. At the bottom of the main configuration area are buttons for 'Add', 'Remove', and 'Remove all'. At the very bottom of the window are buttons for 'Save to gate', 'Load from gate', 'Default', and 'Save to file'.

Fig. 48 – Incoming Group Setting Window

The 2N - VoiceBlue Lite gateway allows you to work with four groups of incoming calls. You can select different settings for each of them with respect to establishing incoming calls. To set the default parameters use the *Default* button. The meanings of the card items are as follows:

- *Mode* – set the way the GSM gateway shall process incoming calls from the GSM network:
  - *Reject incoming calls* – all incoming calls from the GSM network are rejected automatically.
  - *Ignore incoming calls* – all incoming calls from the GSM network are ignored automatically. The calling subscriber hears the ringing tone.
  - *Receive incoming calls + voice message* – incoming calls from the GSM network are received and, if defined so, the voice message is enabled for the incoming call while awaiting digits in DTMF.

- *Receive incoming calls + dialtone* – incoming GSM calls are received and, if defined so, the simulated dial tone is enabled for the incoming call while awaiting digits in DTMF.
- *CallBack after ring / Reject* – in case the CLIP is included in the CallBack table, a CallBack is made. The GSM gateway rejects the incoming call and makes an automatic CallBack.
- *CallBack after ring / Ignore* – in case the CLIP is included in the CallBack table, a CallBack is made. The incoming call is ignored. If the calling subscriber does not hang up within the defined timeout (default = 10s), the CallBack function is ignored and the call is processed normally (refer to Subs. 7.5).
- *Report to PC + voice message* – the GSM gateway sends information on an incoming call to a PC equipped with call routing software. The DTMF with a voice message may be enabled for the incoming call.
- *Report to PC + dialtone* – the GSM gateway sends information on an incoming call to a PC equipped with call routing software. The DTMF with a simulated second dial tone may be enabled for the incoming call.
- *Min. digits in DTMF* – the minimum number of digits required by the gateway in the DTMF.
- *Max. digits in DTMF* – the maximum number of digits accepted by the gateway in the DTMF.
- *Tout for entering DTMF digits [s]* – a timeout during which the GSM gateway waits for the first / another DTMF digit. If 0 is selected, the incoming call is connected automatically to the numbers included in the *List of called numbers*.
- *Day of deleting incoming stats*– defines a day in a month on which statistical data on incoming calls are deleted. By setting this parameter at 0 you disable this function.
- *Prefix before DISA* – a digital prefix to precede the DTMF automatically.

- 
- *CLIP* – the '+' character from the CLIP shall be replaced with a sequence of digits included in this field.
  - *CLIP to VoIP separator* – if this field is not empty the VoiceBlue Lite checks the CLIP from GSM whether contains character filled in this item. If the character is present in incoming CLIP VoiceBlue automatically dials number following this character to VoIP network.

Example:

“*CLIP to VoIP separator*” = “#”. If the CLIP from GSM is +420123123123#999 VoiceBlue Lite automatically dials 999 to VoIP network

- *Time to keep CLIP in table [hours]* – enter the time in hours for how long should be the incoming calls routing record kept in the dynamic CLIP routing table. The routing records are added to the table automatically by establishing of outgoing call to the GSM network. Incoming calls are routed to the extension, which called the incoming CLIP as the last.
- *Add record only for unconnected call* – only unconnected outgoing calls to the GSM records will be added to the dynamic CLIP routing table by selecting of this item.
- *Delete record for connected answer* – dynamic CLIP routing record will be removed from the table when the originally called party in the GSM network calls back and is linked to the originally calling extension in the VoIP network.

## Network list

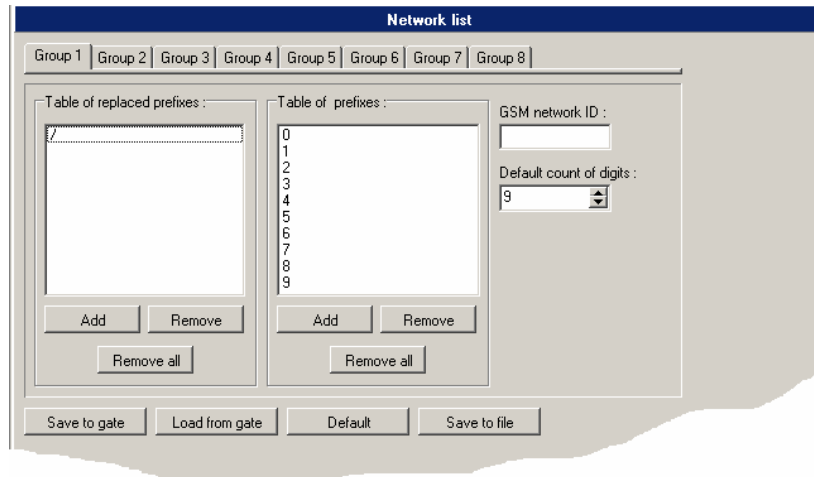

Fig. 49 – GSM Calling Group Defining Window

The Network list helps the gateway connect calls to various GSM networks. You can define call routing by prefixes in eight groups. You will find the following items in the editing window:

- *Table of replaced prefixes* – a table of prefixes to be replaced (e.g. '+420' with '0'). This change is made before the prefix table is checked.
- *Table of prefixes* – a table of called prefixes. You can define the dialling length too here. If you do not enter the dialling length, the *Default count of dialling digits* will be used automatically.
- *GSM network ID* – a numerical identification code of the selected prefix table used for internal identification purposes only. It has no influence on call routing.
- *Default count of digits* – used for defining the count of digits to be considered if the count is not included in the prefix table.

## LCR table

The LCR (Least Cost Routing) table helps define the call routing procedure according to the called subscriber's number depending on the day time and day in a week (refer to Subs. 7.3).

The LCR table setting using the GSM configuration software is discussed in this subsection.

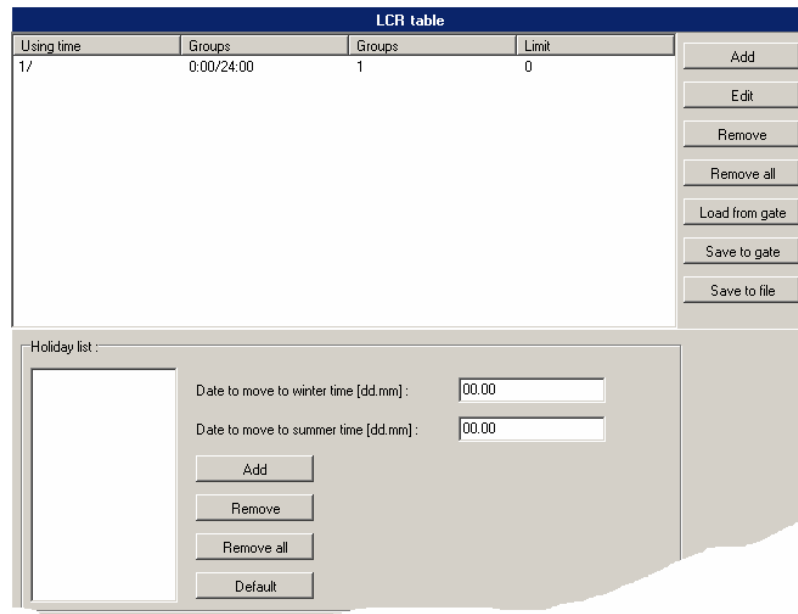

Fig. 50 – LCR table

- *Add* – this button adds a record into the LCR table. By pressing it you open the editing window (see Fig. 51).

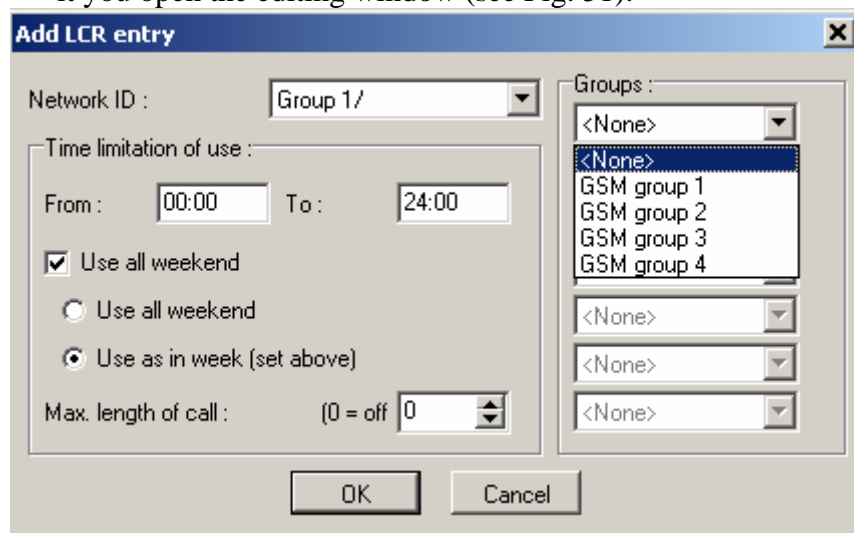

Fig. 51 – LCR table Completion

By completing the LCR data adding table you set one call routing rule.

- *Network ID* – select a group (GSM network) from a pull-down menu to which the routing rule should apply. The group settings are discussed in the *Network list*.
- *Groups* – this list helps define the outgoing call groups (refer to *GSM outgoing groups*). All outgoing calls are routed to the network selected in the *Network ID* parameter. The routing priority is from top to bottom. Therefore, if the top parameter (GSM group 1) cannot be used, the call is routed according to the parameter under the first one.
- *Time limitation of use* – sets the time limit for the routing rule defined in this menu. The time validity *From – To* may include weekends too
- *Max.length of call* – limits the call duration to the network selected in *Network ID* through the GSM group selected in *Groups*. To disable the call duration limitation set the value at *0*.
- *Edit* – you can edit a routing rule from the LCR table by pressing this button.
- *Remove* – deletes a routing rule selected from the LCR table list.
- *Remove all* – removes all entries from the LCR table
- *Load from gate* – downloads entries of the LCR table from the gateway
- *Sae to gate* - uploads entries of the LCR table to the gateway
- *Save to file* – saves LCR table to the configuration file of the gateway.
- *Default* – sets default values of the LCR table
- *Holidays list* – a list of days on which VoiceBlue Lite shall route outgoing calls according to the weekend LCR table.
- *Date to move to winter time [dd:mm]* – enter the day on which summer time should be changed into winter time for LCR purposes.

- 
- *Date to move to summer time [dd:mm]* – enter the day on which winter time should be changed into summer time for LCR purposes.

### **Autorouting Table**

Autorouting table is instrumental to permanent routing of incoming calls from GSM network to respective VoIP extensions. Moreover the Autorouting table serves for managing of Callback function for incoming CLIPs from GSM network. Callback function makes it possible to call to VoIP network at the expense of SIM cards inserted in VoiceBlue (see Fig. 52). If this function is allowed for the callers CLIP and the caller calls VoiceBlue, VoiceBlue rejects the call. After rejecting the call VoiceBlue establishes new call to the caller. After accepting the call on caller's site, voice message or dial tone is play backed to the caller. VoiceBlue accepts the caller dialling and after that establishes call to appropriate destination in VoIP network.



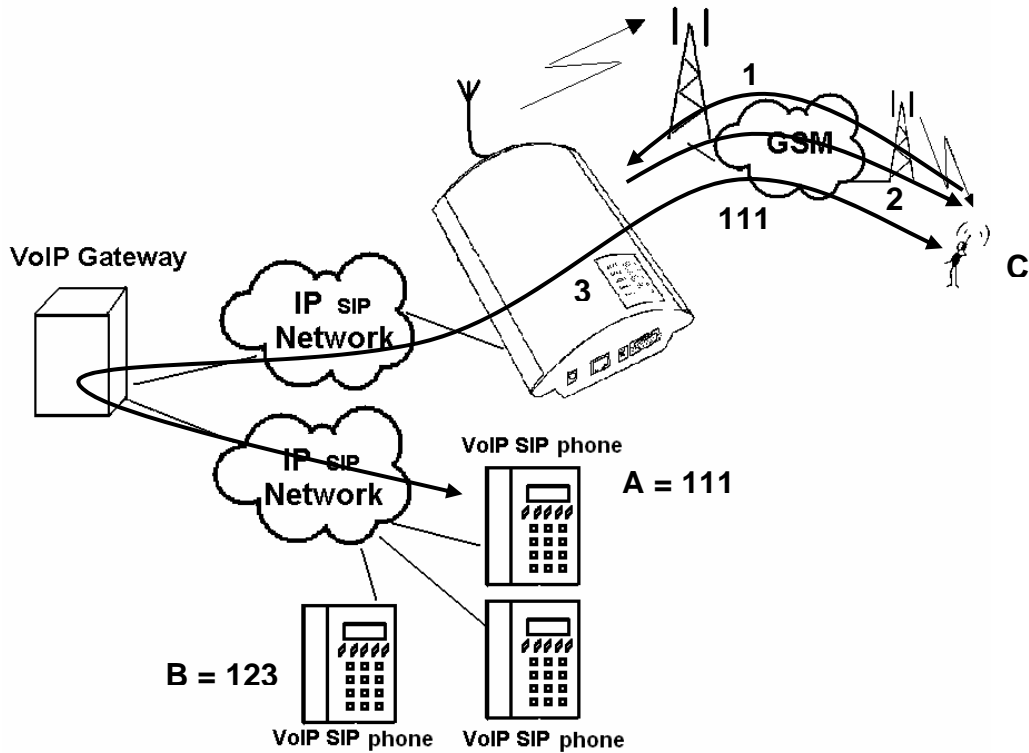

Fig. 52 – Callback function

Autorouting table			
GSM number (clip)	Dial (to VoIP)	Limit	Autorouting type

Add

Edit

Remove

Remove all

Load from gate

Save to gate

Save to file

Fig. 53 - Autorouting table

- *Add* – this button is intended for adding of new record to the autorouting table. The window shown on the Fig. Fig. 54 opens by clicking this button.

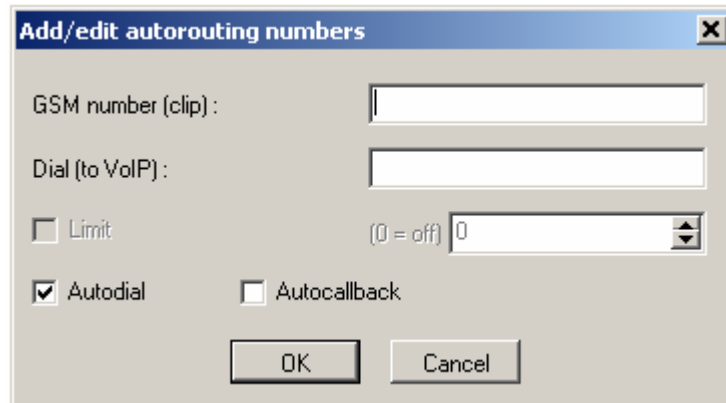

Fig. 54 – Add/edit autorouting numbers

- *GSM number (CLIP)* – field for the GSM number, for which will be autodial or autocallback function applied. CLIP must be entered in the same format as is presented by GSM network (the same as is for incoming calls shown on GSM phone display).
- *Dial (to VoIP)* – incoming GSM calls will be routed to the VoIP extension number filled in this field
- *Autodial* – selecting this item all incoming calls with CLIP filled in *GSM number (CLIP)* will be routed to the extension number filled in *Dial (to VoIP)* field.
- *Autocallback* – selecting of this item activates Autocallback function. The autocallback routine is activated after the calling party in the GSM network hangs up. If the field *Dial (to VoIP)* is filled in, the VoiceBlue Lite establishes connection to the extension in the VoIP network while establishing of the call to the GSM network. If the *Dial (to VoIP)* field is empty, the VoiceBlue Lite establishes connection back to the GSM and after the accepting of the call plays back the dial tone or voice message and awaits DTMF digits.
- *Limit* – setup the maximum length of call. Value “0” disables this function.
- *Edit* – for editing of autorouting table records. Clicking this button opens the window shown on Fig. 54.

- *Remove* – for removing of autorouting table records. Clicking this button removes selected record from the table.
- *Remove all* – removes all entries from the Autorouting table
- *Load from gate* – downloads the Autorouting table from the VoiceBlue Lite
- *Save to gate* – Uploads the Autorouting table to the VoiceBlue Lite
- *Save to file* – saves Autorouting table to the configuration file of the gateway.

## Mobility extension

Mobility extension						
Name	User	Password	CLIP (GSM num...	"Follow me" fun...	"SMS at no ans...	Register...
8711	8711	8711	737737374	Enabled	Enabled	Register...

Add

Edit

Remove

Remove all

Load from gate

Save to gate

Save to file

Fig. 55 – Table mobility extension

Through this table, the service mobility extension is permitted for the individual subscribers. The service mobility extension is described in section 6. In the mobility extension table, the subscriber is recorded not only under the VoIP address, but also under his CLIP. Subscribers may be permitted the function of “Follow me” (see Fig. 19) and “SMS at no answer” (see Fig. 20).

- *Add*– this button adds a record to the table mobility extension. After it is clicked, the add/edit record window appears, which is shown in Fig. 56.

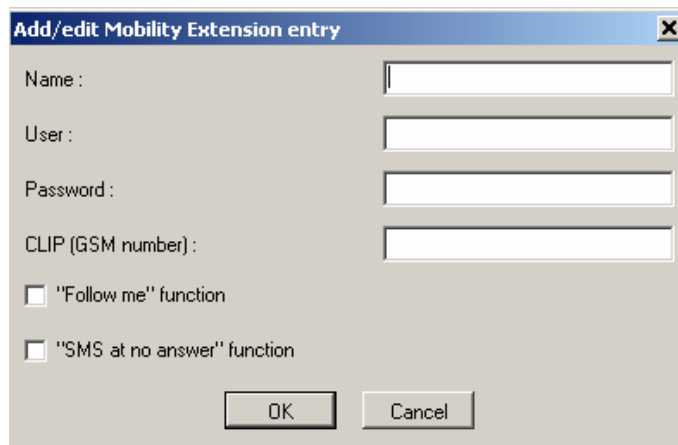

Fig. 56 – Window of editing table of mobility extension

- *Name* – user name
- *User* – user name for authentication
- *Password* – Password required for authentication with SIP proxy
- *CLIP (number GSM)* – insert CLIP of GSM telephone to which calls will be forwarded if the subscriber shown in the field URL (user@domain) is not available. From this CLIP it will also be possible to permit the rerouting of calls and sending of text messages about missed calls. From this CLIP it will also be possible to perform parking and rerouting of calls.
- *Function "Follow me"* – allows for a given subscriber rerouting to the GSM network in the case of unavailability in the VoIP network
- *Function "SMS at no answer"* – allows for a given subscriber the sending of text messages about missed calls.
- *Edit* – for editing of Mobility extension table records. Clicking this button opens the window shown on Fig. 56
- *Remove* – for removing of autorouting table records. Clicking this button removes selected record from the table.

- *Remove all* – removes all entries from the Mobility extension table
- *Load from gate* – downloads the Mobility extension table from the VoiceBlue Lite
- *Save to gate* – Uploads the Mobility extension table to the VoiceBlue Lite
- *Save to file* – saves Mobility extension table to the configuration file of the gateway.

## 9.6. Reset

The items are available only if your VoiceBlue Lite gateway is connected. This menu contains *Gateway reset* for software resetting of the gateway and *Factory parameters reset*.

---

# 10

## SECTION 10

---

### **Configuration of External Callback**

This section will guide you through installation and configuration of external callback software. The External Callback software is optional part of system. When you do not use external callback function you can skip this section. For additional information please contact 2N sales.

Here is what you can find in this section:

- Introduction to the External Routing Software
- Installation and configuration of XAPI server
- Entering licenses to XAPI server
- Registering of users
- Installing and configuration of Callback Centre

## 10.1. Introduction to the External Routing Software

The External routing system consists of two types of software. The XAPI sever which is installed on the PC connected to several gateways and clients communicating with the XAPI server. The basic scheme of configuration and callback routing is shown on Fig. 57.

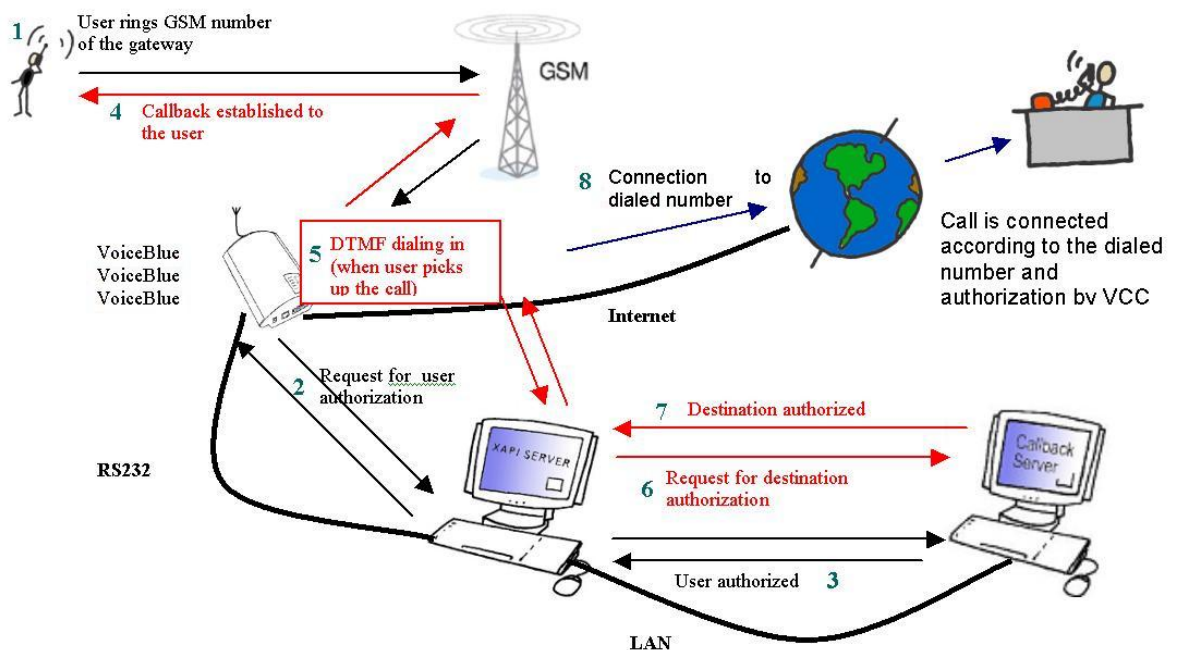

Fig. 57 – Scheme of external Routing system

## 10.2. Installation and configuration of XAPI server

To launch installation of XAPI server run the SETUP.EXE file attached on the CD. After successful installation run the XAPI server application. The main window shown on Fig. 58 opens after start of XAPI server.



Fig. 58 – Main XAPI server window

At the beginning of configuration is needed to setup the communication of XAPI server with the gateway. Click to “Set” in the main XAPI window and then choose “Module-PBX” item. In the PBX settings disable COM port by selecting “---” and click OK (see Fig. 59)

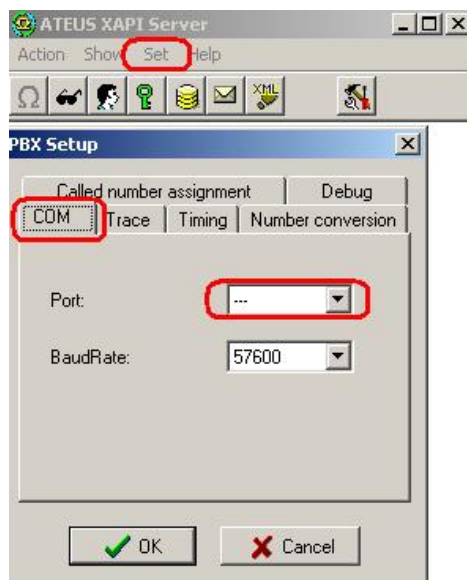

Fig. 59 - Communication configuration

After that setup the COM port the GW is connected to. (Serial connection is recommended for Voice Callback.) For setup of the COM port click the “SMS“ button and than “Set“ button or “Set” in the main XAPI window and then choose “Module-SMS” item. In SMS setup window select “Ext. gates” and configure parameters of connected gateway such as port the gateway is connected to, baud rate, user name and password. At the end do not forget to choose the VCC automat for processing of incoming information from the gateway. (See Fig. 60). At the end confirm changes by clicking “OK“ button.



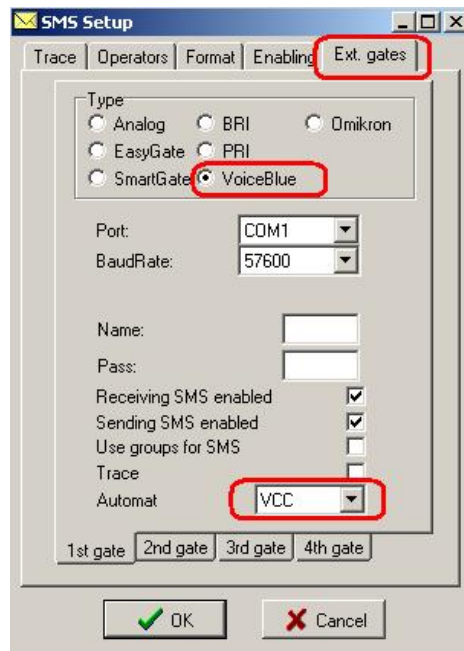

Fig. 60 - SMS setup window

Press “SMS“ button to open “SMS window“. If the communication was setup correctly, signal status of GSM modules shows up in status gateway window. The XAPI server is successfully installed.

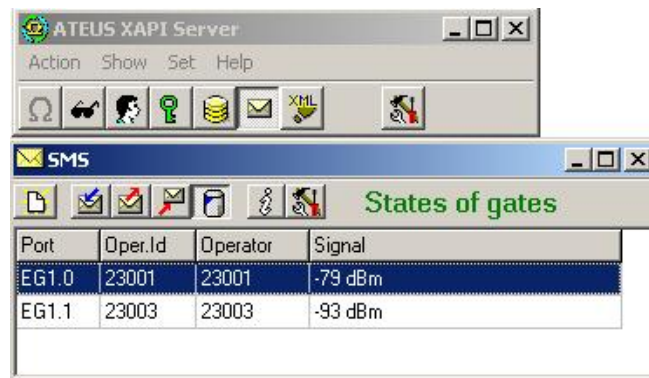

Fig. 61 - Status of GSM modules

---

### 10.3. Entering licenses to XAPI server

Start the following configuration only if the XAPI sever was correctly configured and communicates with the gateway. For configuration of XAPI server see sub. 10.2.

It is needed to enter valid license code to XAPI to activate Voice Callback centre. License is generated by 2N according to request service and serial number of gateway.

To find out what serial number gateway has, start terminal in configuration program or HyperTerminal. Connect to the gateway. Make sure, that the selected COM port, which you try to open and connect to the gateway, is not the same as the COM port, which is opened for communication with XAPI server. Type command: "ati4". The gateway answers serial number (SNumber), MAC address (MacAdr), enabled protocols (Enabled) and limit. Copy the serial number (M113-aaabbbcccd) and send it to 2N technical support.

Answer from 2N should contain these keys:

**Id=xxxx-yyyy Key=aaaa-bbbb-cccc-dddd**

Click "Licenses" button and after that in License window click "Set License".

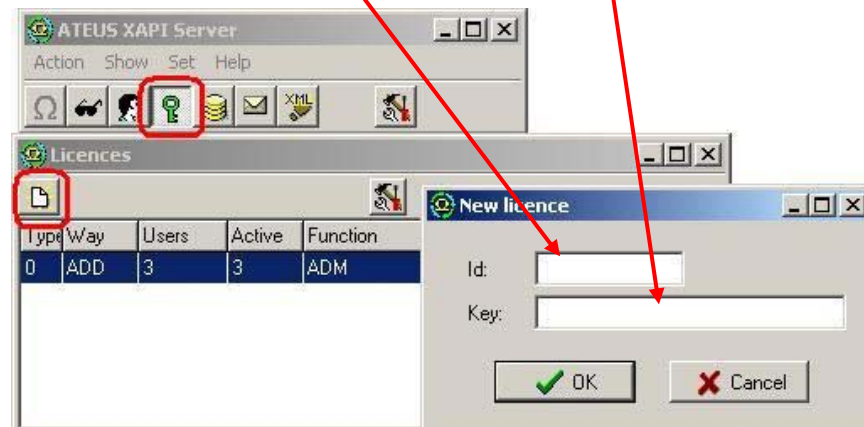

Fig. 62 - Entering the licence

It is not possible to enter license when the gateway is not connected to the XAPI server (response is BAD LICENCE!)

## 10.4. Registering of users

After entering of the license it is needed to create account for new user of XAPI server. To create new user account click “Open Users“ button, which opens Users window. In Users window click “Users“ button a after that “New User“ (see Fig. 63)

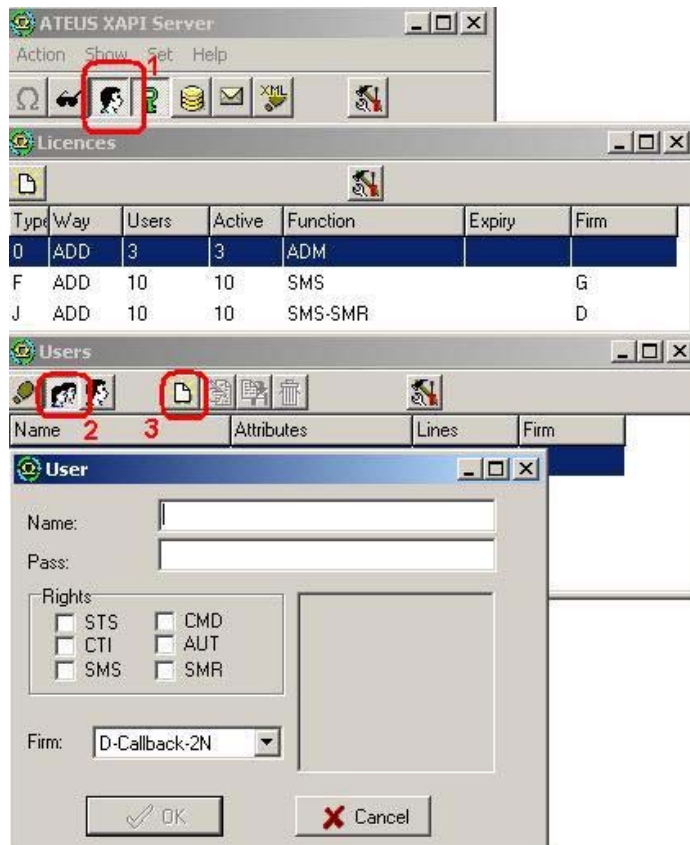

Fig. 63 - New user window

Fill in User name and password to the account and select properties of the user. User properties are given by type of license. (See Fig. 64)

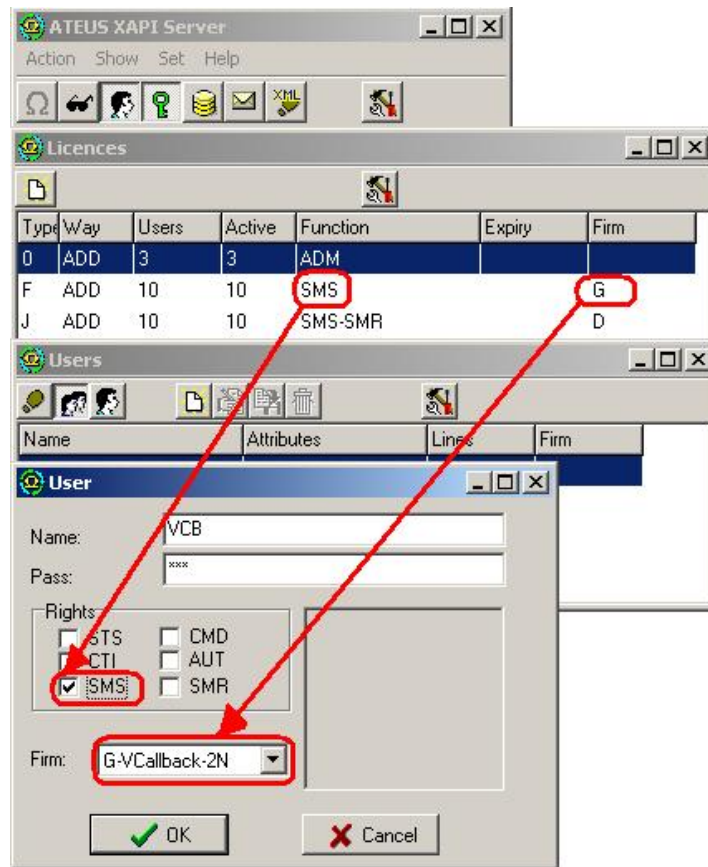

Fig. 64 - New user account properties

Confirm adding of new user account by clicking “OK“ button.

## 10.5. Installing and configuration of Callback Centre

Install Voice Callback Centre from the CD. After installation is necessary to set the communication of Voice Callback Centre with XAPI server. As shown on the Fig. 65, set the username and password (the same user account as in XAPI server) and IP address of PC, where the XAPI server runs. In case that XAPI server runs on the same PC you should add IP address of local host (127.0.0.1).

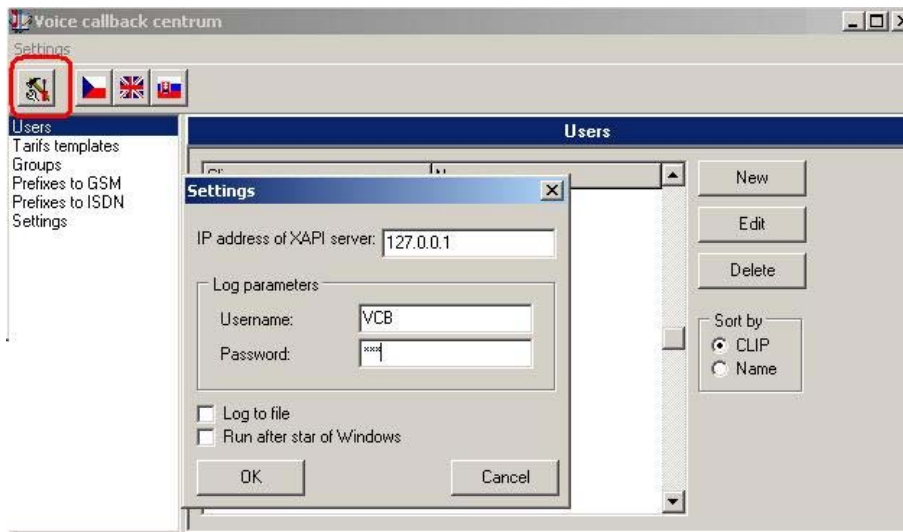

Fig. 65 - Voice Callback centre settings

In case that the XAPI server is correctly configured and access parameters are properly set, the Voice Callback centre software will automatically establish connection with XAPI server.

It is possible to check that also in the LOG of Voice Callback Centre where you may see parameters of connection and type of license.

```
06/01/31,15:40:47:*** Connecting XAPI server...
06/01/31,15:40:47:*** Waiting for answer...
06/01/31,15:40:47:*** Logging in...
06/01/31,15:40:47:*** XAPI ver 1.13 B (DF7D-C82E)
06/01/31,15:40:47:*** VOICEBLUE found on port 'EG1'. Activated!
06/01/31,15:40:47:*** Valid license found. Maximum number of users : 1000.
```

Fig. 66 - Communication LOG

Each GSM user that is allowed to use Voice Callback service must be added to “users table” and must have filled up following parameters: Name, CLIP (identification of user phone) and right tariffs (credits) for each group (destination).

In case, that you are adding more new users you can use tariffs templates, which you will assign for each new user.

On Fig. 67 is shown, that Pavel has phone number +420605123456 and credit rights for destination Group 1 only

from midnight to noon. Credit for month is 200 minutes. The user was created with using template “Tariff 1”.

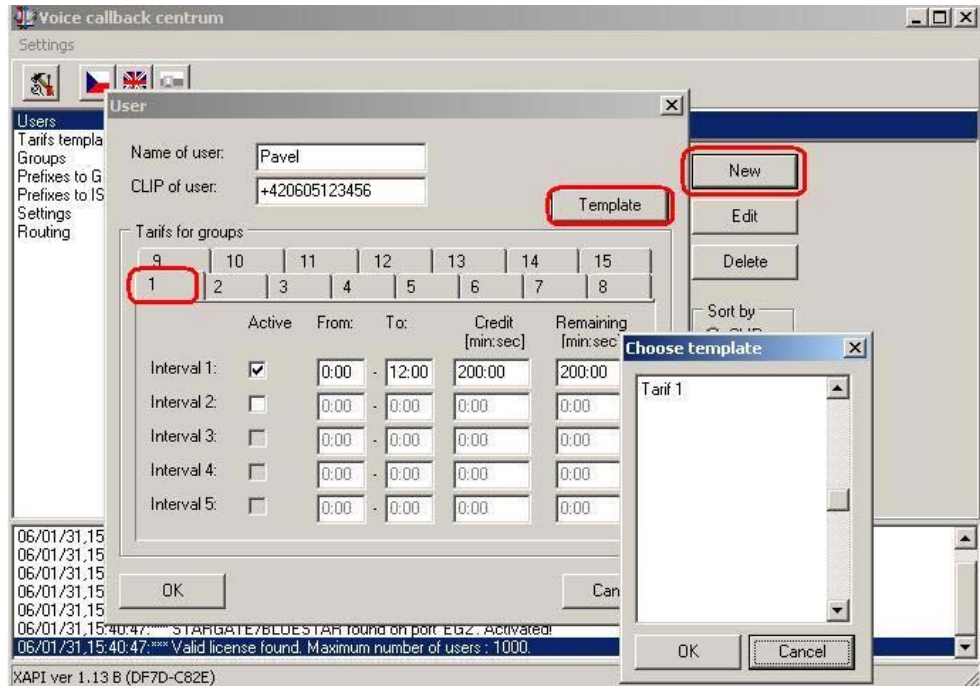

Fig. 67 - New user

Groups are used for definition of destinations which is the user allowed to call. In the Fig. 68 is shown, that the user is allowed to call destinations with prefixes +420 and +421. Prefixes to GSM are not actually used. Please do not change these tables.

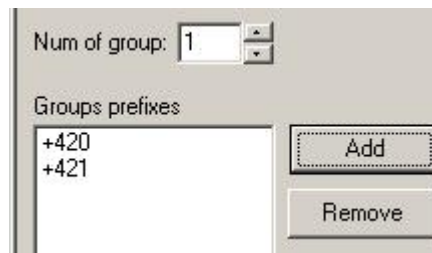

Fig. 68 - User Groups

There is possible to set the day of the restoring credits for users as well as the relax delay between two callback (recommended time is 10 sec.) in the settings section. SMS message, which will be

automatically send to user in case of defined event can be activated in this section as well.

**Configuration of SMS Callback centre is almost the same as configuration of Voice Callback centre.**

---

# 11

## SECTION 11

---

### **Configuration Using Terminal**

It is possible to communicate with the 2N - VoiceBlue Lite gateway through a serial cable, USB port connected as a virtual COM port, or through a TCP/IP connection. All the connections allow for a uniform way of gateway configuration using AT commands.

Here is what you can find in this section:

- Serial Communication Setting
- USB Communication Setting
- TCP/IP Communication Setting
- Terminal Communication
- GSM Gateway Behaviour



- List of Terminal AT Commands
- Records on Operation (LOG)
- Records on Calls (example)
- Statistics – Description

### 11.1. Serial Communication Setting

Use a full crossed (laplink) RS232 cable for serial communication. Also set the following communication parameters:

Communication rate:	57,600 bps
Number of bits:	8
Stop bits:	1
Parity:	none
Flow control:	Hardware
File transmission protocol:	XMODEM

### 11.2. USB Communication Setting

To establish USB communication, install the enclosed driver, which installs a virtual COM port in the Windows system. You can, e.g., use the *HyperTerminal* communication software for communication. Set the following parameters:

Transmission rate:	921,600 bps
Data bits:	8
Parity:	none
Stop bits:	1
Flow control:	none

### 11.3. TCP/IP Communication Setting

To communicate with the 2N - VoiceBlue Lite gateway through the LAN, set the LAN IP address first. To do this you need a direct serial or USB PC connection. You can use such TELNET supporting programs for TCP/IP communication as *HyperTerminal*, *Putty*, etc.

---

IP address:	gateway address set by you
Port:	23

## 11.4. Terminal Communication

The terminal is also part of the GSM configuration software. To start the terminal use the *CTRL – Terminal* button menu. Be sure to configure the GSM program properly for communication (refer to Subs. ).

## 11.5. GSM Gateway Behaviour

The gateway behaves as an ANSI terminal with an echo. The commands are entered in the text format and the X-modem protocol is used for file transfer. An access password is required, the gateway returns the *USER* and *PASSWORD:* prompts; if the password has been entered or is not required, the '>' prompt is used. The gateway uses an extended set of AT commands for configuration. For the list of AT commands see below.

## 11.6. List of Terminal AT Commands

All commands start with AT by default. (Note: Some of the below mentioned AT commands may not be available in the current firmware versions.)

### Basic AT commands

A/	repeat last command (without AT)
I3	copyright & firmware
I4	serial number
&FRES	factory defaults & reset
&V	view active parameters (system)
&VE	view active parameters (ethernet)
&V0	view active parameters (common)
&V1	view active parameters (groups 1..4)
&V9	view active parameters (inc. groups)
&P	view pseudo params
&N#	view network params (net 1..8)
&NALL	view all network params

&A	view autorouting table <SPACEcontinue>
&R	view lcr-routing table <SPACEcontinue>
&TIN	view lan + groups + modules inc totals
&TOUT	view lan + groups + modules out totals
&G#=atcommand	send at command to gsm 1..4
&GALL=cmd	cmd for gate 1..4 (RESET,BLOCK,OFF)
&G#=cmd	cmd for gate 1..4 (RESET,BLOCK,OFF,ATBAUD)
&S	view lan + modules status
&S=info	view all modules selected info (by at&S#)
&S#	view one module status (1..4)
&QALL	view signal quality on all gsm
&Q#	view signal quality on gsm 1..4
&L	view logfile from recent <SPACEcontinue>
&C	view buffer (calls) from recent <SPACEcontinue>
&CR	read buffer from the oldest <#erase & continue>
&BSYS=cmd	cmd for system (RESET)
&X	view conn table/gsm (call states)
&X#	view call details/gsm (1..4)
&M0	disable ansi colors
&M1	enable ansi colors
&M9	start matrix
&U	view logged users

## Extended user commands

&EA	view arp table
&EA=cmd	cmd for arp table (RESET)
system params:	
%S70=iii.iii.iii.iii	IP address
%S71=iii.iii.iii.iii	IP mask
%S72=iii.iii.iii.iii	IP router
%S91=buf,id	cdr mode bits (b0=outg, b1=inc, b2=failed, b3=moninfo) unit id (0=off, 1..255)
%S92=rep	report mode (b0=states, b1=tstamp, b2=smp, b3=lay2, b4=select)
%S98=pin	sim pin (max 7 digits)
%S99=dd.mm.yy.w/hh.mm.ss	set date/time (w=1..7 day of week)

---

%X20=mmdd,mmdd date of hour+1,hour-1 time change (0=off,0101..1231)  
%X80=login/pass login name / password (max 15 chars all)

## Ethernet parameters:

%E00=xxx protocol (==I00)  
%E01=c1,c2,c3 codec list (18,8,0) (0=PCM uLaw, 8=PCM ALaw, 18=G729, 4=G723), 4 and 18 is not possible to use together  
%E02=exp,rep,stun expire (sec >= 600), reattempt (sec >= 10) for sip.reg.,stun timeout  
%E03=rtp1,rtp2 rtp ports first (>=1024), last (>=first+10) RTP port, even only !  
%E08=bits bit0=reserved  
bit1= 1 - send "180 RINGING", 0 - send "183 SESS. PROG"  
bit2 = 1 - send "200 OK" instead of 180/183  
bit3 = 0 - 486 is sent on rejected call, 1 - 200 and BYE id sent on rejected call  
%E09=day day (0=off,1..31) of clearing stat  
%E10=x.x.x.x:port SIP proxy for calls IP-->GSM:port number used for outgoing SIP packets  
%E11=x.x.x.x:port SIP proxy for calls IP<--GSM:port number for incoming SIP packets  
%E14=x.x.x.x:port SIP registrar:port number used for registration  
%E16=x.x.x.x NAT firewall  
%E17=x.x.x.x:port STU IP address:port. For IP = 0.0.0.0 is this function disabled. Default port = 3478  
%E20=blocks,bits codec parameters for PCMA and PCMU, blocks (1..20), bits (0..255) - 8 control bits, bit0 = 1 support of silence  
%E23=blocks,bits codec parameters for G.723, blocks (1..4), bits (0..255) - 8 control bits, bit0 = 1 support of silence, bit1 = 0 - high bit rate 6,3 kbps, 1 - low bit rate 5,3 kbps  
%E29=blocks,bits codec parameters for G.729, block (1..10), bits (0..255) - 8 control bits, bit0 = 1 support of silence  
%E80=name/pass registration name / password (max 31 chars all) for proxy server  
%E81=domain domain (max. 31 char)

## Group parameters:

%G00=xxxx out.group numbers for g1..g4 (0=off, 1..4=group)  
%G01=0,dspo,dspi dsp signal gain level output,input gain (1=-31dB, 32=0dB, 63=+31dB)  
%G01=2,atms,afms dsp signal gain dtmf level during test period  
%G02=mode,atms,afms tc35 mode (2,4)

%G06=mmdd,..mmdd	atms/afms gain (+5dB=3,+2.5dB=1,0dB=0,-2.5dB=2,-5dB=4)
%G07=mmdd,..mmdd	holiday list (0101=1st jan, 1231=31st dec)
%G08=delay,min,max,tout	holiday list2
	gsm call delay (0..10 sec), dial min/max (0..20)
	dial tout (0..20 sec)
%G09=scn	sim card number (0=imsi,1=scid)
%G#1=netid,clir,min,sms,day,sec,sec2,pseudo	group #1 params
	netid (7 chars), clir (0=netw,1=on,2=off)
	min (0=off,1..65535 minutes), sms (0=off,1..65535)
	day (0=off,1..31), sec/2 (1..250), pseudo (0=off,1..8)
%G#9=ale,conn,disc,day	# group number
	alerting tout (0=off,1..20sec), conn delay (0..20sec)
	forced disc (0=off, 1=on sim limit, 2=on sim or time limit)
	day (0=off,1..31) of clearing group stat,
%G90=xxxx	inc.group numbers for g1..g4 (0=off, 1..4=group)
%G9#=mode,min,max,tout,day,dial,clip	params #=1..4 for inc.groups 1..4
	mode (0=reject,1=ignore,2=ok-message,3=ok-tone,4=callback
	mess,5=callback tone,6=PC+message,7=PC+tone)
	Min digits in DTMF (0..20), max digits in DTMF (0..20) tout
	(0..20s) dtmf dial-in
	day (0=off,1..31) of clearing inc.group stat
	dial prefix (max 15 ch), clip prefix (max 7 ch)
%G95=	multiple listing of extensions (sending of INVITE message to
	another extension on receipt of 4xx response)
%G96=	multiple listing of extensions
%G97=	multiple listing of extensions
%G98=	multiple listing of extensions
%G99=exp,bits	Exp=0 dynamic CLIP routing off. 1 dynamic CLIP rout on,
	Bit0=1 add record for unconnected call only
	Bit1=1 delete record after connected

### Pseudotarif params:

%P01=c/HH:MM,...,c/HH:MM	pseudo tarif cents/until (cents=1..9999) (63 chars max)
	(until=00:00 must be first the item, that is valid on all weekends)
	(until=24:00 must be the last last mandatory item)
%P02=uuu/HH:MM,	pseudo tarif extension
%P03=uuu/HH:MM,	pseudo tarif extension
%P04=uuu/HH:MM,	pseudo tarif extension
%P05=uuu/HH:MM,	pseudo tarif extension
%P06=uuu/HH:MM,	pseudo tarif extension

---

%P07=uuu/HH:MM,	pseudo tarif extension
%P09=mode,sec	pseudo mode (0=off,1=cdr,2=cdr+lan), count of secbetween AOC (1..250)

## Network params:

%N#0=opx/npX,	list of old/new main-prefixes (max 47 chars)
%N#1=pref/dig,	list of prefixes/digits-to-end (max 63 chars)
%N#2=pref/dig,	pref. list extension (max 63 chars)
%N#3=pref/dig,	pref. list extension (max 63 chars)
%N#4=pref/dig,	pref. list extension (max 63 chars)
%N#5=pref/dig,	pref. list extension (max 63 chars)
%N#6=pref/dig,	pref. list extension (max 63 chars)
%N#7=pref/dig,	pref. list extension (max 63 chars)
%N#9=netid,max	network id (7 chars), default max digits (0..20)

## Routing params:

%A##=clip,dial	Autodial (autocallback restricted) clip=clip from GSM, dial=dial to VoIP
%A##=clip,dial,limit	Autodial or autocallback clip=clip from GSM, dial=dial to VoIP,limit=max length of call
%A##=clip,,limit	Autocallback (autodial restricted) clip=clip from GSM, ,limit=max length of call
%R##=net,hh:mm/hh:mm/w+-,groups,lim	set lcr-routing item (ix 0..63) net (1..8), groups (max 7 chars=1..9) call limit (0=off, 1..99min)

## DISA record commands

!m=erase	erase of DISA message
!m=record	record of DISA message from modul g0
routine for DISA record	establish call to GSM: at!sg0={GSM phone number} after connect type: at!m=record recording of the message (65 sec or press <ENTER> to finish) hang ap on VB site: at!d

## Totals

; first m,c,s	inc. minutes,calls,smses
; second m,c,s	out. minutes,calls,smses

; ri,ro	redirected inc,out calls
% TL=m,c,m,c	init minutes,calls in lan (0..65535)
% TG#=m,c,ri,ro	init minutes,calls,rin,rout in group # (0..65535)
% TGALL=m,c,ri,ro	init minutes,calls,rin,rout in all groups (0..65535)
% TI#=m,c	init minutes,calls in inc.group # (0..65535)
% TIALL=m,c	init minutes,calls in all inc.groups (0..65535)
% TM#=m,c,s,m,c,s	init minutes,calls,sms in mod # (0..65535)
% TMALL=m,c,s,m,c,s	init minutes,calls,sms in all modules (0..65535)

### Service AT commands:

!V0FB=key	set system key
!RE	report errors only
!RR	start report layer2..4 on COM1 (from COM2)
!RX	stop report layer2..4 on COM1 (from COM2)
!R#	report messages 1=layer1..4 2=layer2..4 3=layer3..4 4=layer4
!L#	report lan 2=ip/arp..telnet 3=tcp/udp..telnet 4=telnet
!P	view process info
!Q	view system info
!SG##=ddd,ccc	setup new call from AUX to gsm (0..31,32=by prefix)
!SP##=ddd,ccc	setup new call from AUX to SIP/IP (%E11) ## is ignored
!SE##=ddd,ccc	setup new call from AUX to SIP/IP (%E11) ## is ignored
!WG##	wait on call from gsm 0..31,32=all to aux
!WE##	wait on call from pri2 1..15,17..31,32=all to aux
!D	disconnect call from/to aux
!G=A9	Starts ext. callback control
!SB##=VoIPdial,gsm,dial,limit	Setup new callback VoIPdial=number dialed to VoIP, gsm,dila=number dialed to GSM, limit=max.length of call

### Special GSM commands:

at&g##=at+cnum	view own number
at&g##=at+cpin="####"	set pin (before pin checking off !!!)

---

at&g##=at+clck="SC",0,"####"	pin checking off (####=PIN)
at&g##=at+clck="SC",1,"####"	pin checking on (####=PIN)
at&g##=at+cpin="****"	set pin (before pin changing pin !!!)
at&g##=at+cpwd="SC","****","####"	pin change (****=old, ####=new PIN)
at&g##=at+cacm?	accumulated call meter
at&g##=at+camm?	maximum call meter
at&g##=at+cpuc?	call meter currency/unit
at&g##=atbaud	sets modulation rate of GSM module at 9600 Bd
at&g##=xt...	is used for special commands for GSM module



## Work with SMS

### SMS sending and receiving commands

AT!G=A6 Start low-level controlling for SMS messages (can run only on one port)  
 AT!G=55 Stop low-level controlling on used port

### Control SMS Messages

AT^SX=ch (sms listing) request to list all SMS messages and status confirmations saved on SIM card. Possible answers:: \*smserr (busy,list) or \*smsinc (ix=1..255) for each saved SMS or status SMS , end of list or empty SIM card - \*smsinc (ix=0).  
 AT^SR=ch,ix (sms read) request to read SMS message or SMS status saved on SIM card. Possible answers: \*smserr (busy,read) or \*smspdu  
 AT^SD=ch,ix (sms delete) request to delete SMS message (or SMS status message). Possible answers: \*smserr (busy,delete) or \*smsdel  
 AT^SM=ch,len,pdu,csum (sms to module) request to send message via GSM module 0..31 or via any GSM module (ch=32). Possible answers: \*smserr (busy,write) or \*smsout  
 AT^SG=grp,len,pdu,csum (sms to group) request to send SMS message via GSM group 1..8. Possible answers: \*smserr (busy,write) or \*smsout

### Reports from VoiceBlue Lite

\*smsinc: ch,ix,sts SMS message was received and saved to SIM card:  
 Ch ...GSM module number 0..31  
 Ix ...index number of saved SMS messages 0..255  
 Sts ...status of SMS message  
 \*smsrep: ch,ix SMS status confirmation was received and saved to SIM card (this message is only for GSM modules TC35 and GM47)  
 \*smsout: ch,ix,ref SMS message was sent and not saved into SIM card:  
 Ref ...reference number of sent SMS 0..255 (will be used in SMS status confirmation message)  
 \*smspdu: content of SMS message or status confirmation:  
 ch,ix,sts,len,pdu,csum Len ...length of SMS message (number of bytes in pdu)  
 Pdu ...content message in PDU format  
 Csum ...Checksum of all PDU bytes (2 hexa digits) calculated without carry  
 \*smsdel: ch,ix SMS message or status confirmation was deleted from position ix  
 \*smserr: ch,ix,req,err response to error command:  
 Req ...required GSM module or GSM group  
 Err ...error code (6=busy, 40=write, 41=read, 42=delete, 43=list)

## 11.7. Records on Operation (LOG)

Type	Text	Description
POWER	[Power on]	System switched on
	[Power off]	System switched off
	[Warm boot]	Restart of system, unknown cause
	[Watchdog]	Restart of system by watchdog
	[BKPT code]	CPU error: break code detected
	[Stack error]	CPU error: stack integrity failure
	[Divided by zero]	CPU error: dividing by zero
	[RETI code]	CPU error: illegal using of instruction reti
	[NMI intr]	CPU error: wrong interrupt
	[VOID intr]	CPU error: wrong interrupt
	[Upgrade reset]	Start of upgrade firmware procedure
[Software reset]	Reset by AT commands (at&fres...)	
INIT	Eeprom	Initialisation of eeprom (configuration)
	Flash	Initialisation of flash memory (firmware)
HW-ERR	Codec ##,RD/WR	(##...address of chip, RD...read value/WR...expected value)
	Duart #####,RD/WR	Error in initialisation of serial controller on GSM
SYSERR	User stack error!	SW error: stack integrity failure
BRDIN	#08 TYP STS	the board inserted (number of gsm board, type, status)
BRDOUT	#08 TYP STS	the board disconnected
BRDRES	#08 TYP STS	Reset the board by AT command
	ALL GSM RESET CMD	Reset of all GSM modules by AT command
	SYSTEM RESET CMD	Reset of system by command at&bsys
G2-ERR	ATD/ERROR init (g##)	Error of layer 2: restart of module g## after rejected command ATD by GSM network
	GSM Cause 150 (g##)	Error of layer 2: restart of module g## after cause 150 was received (call barred by GSM network)
G3-ERR	tout sts # (g##)	Error of layer 3: timeout in status # on module g##
C4-ERR	tout sts # (p##/g##)	Error of connecting layer 4: timeout in status # on call between channel p## and GSM module g##

## 11.8. Records on Calls (example)

Call data records										
date	time	type	cause	from/to	groups	conn.	durat.	aoc-info	gid	
**	24.05.07/16:21:47	I-OK	CAU-016	g00/v01	GRP-B	0:15	000:53	00000.00	67	+420420420074 1/230010010011001

\*\* 24.05.07/16:21:47      I-OK      CAU-016      g00/v01  
 GRP-B      0:15 000:53      00000.00      (gateway id (optional))  
 +420420420074 (caller's number)      1/230010010011001

- 1st column: \*\*
- 2nd column: call start date/time
- 3rd column: call type
  - I-FD : Unconnected incoming call attempt
  - I-OK : Successfully connected incoming call
  - O-FD : Unconnected outgoing call attempt
  - O-OK : Successfully connected outgoing call
- 4th column: CAUSE sent from GSM
- 5th column: used GSM module number / used VoIP-channel number
- 6th column: used GSM group (C= CallBack )
- 7th column: call establishing time
- 8th column: call duration mmm:ss (max. 255:59) or error cause for unconnected calls
- 8th column: call cost
- 9th column : gateway id (optional)
- 10th column: called number
- 11th column: caller's number
- 12th column: slot number / used SIM card IMSI \*

---

## 11.9. Statistics – Description

### [ Outgoing statistics ]

```
lan (reset) minutes hhhh:mm:ss calls reject failed c.offss errors
-----
#e out (21.11) 3 0:03:21 3 0 0 1 0
gsm (reset) minutes hhhh:mm:ss calls reject failed red.in redout
-----
#g1 out (21.11) 3 0:03:21 3 1 0 1 0
#g2 out (21.11) 0 0:00:00 0 0 0 0 0
#g3 out (21.11) 0 0:00:00 0 0 0 0 0
#g4 out (21.11) 0 0:00:00 0 0 0 0 0
mod (reset) minutes hhhh:mm:ss calls smses
-----
#m0 out (21.11) 0 0:00:10 1 0
#m1 out (21.11) 0 0:00:00 0 0
#m2 out (21.11) 0 0:00:00 0 0
#m3 out (21.11) 0 0:00:00 0 0
[ End of Outgoing statistics ]
```

### [ Incomming statistics ]

```
lan (reset) minutes hhhh:mm:ss calls reject failed c.offss errors
-----
#e inc (21.11) 4 0:04:12 3 0 0 2 0
gsm (reset) minutes hhhh:mm:ss calls reject failed c.offss errors
-----
#i1 inc (21.11) 4 0:04:12 3 0 0 2 0
#i2 inc (21.11) 0 0:00:00 0 0 0 0 0
#i3 inc (21.11) 0 0:00:00 0 0 0 0 0
#i4 inc (21.11) 0 0:00:00 0 0 0 0 0
mod (reset) minutes hhhh:mm:ss calls smses
-----
#m0 inc (21.11) 4 0:04:12 3 0
#m1 inc (21.11) 0 0:00:00 0 0
#m2 inc (21.11) 0 0:00:00 0 0
#m3 inc (21.11) 0 0:00:00 0 0
[ End of Incomming statistics ]
```

- *Pri/grp* - call type
- *Reset* - last statistic reset date
- *Minutes* - number of minutes

- *Hhhh:mm:ss* - the same number converted to time
- *Calls* - number of calls
- *SMS* - number of sent SMS messages
- *Reject* - number of unconnected calls (no free GSM module available)
- *Failed* - number of unconnected calls (rejected by the GSM network)
- *C.off*s - number of unconnected calls (terminated by the calling party)
- *Errors* - number of unconnected calls (wrong requests - dialled prefix, etc.)

---

# 12

## SECTION 12

---

### Technical Parameters

#### GSM

Mobile network type	GSM 850/900 phase installation, EGSM 1800/1900 MHz (according to the GSM module used)
SIM card	plug-in 3 V ("small")
Transmission power	2 W (1W)
Receiver sensitivity	-104 dBm

#### Antenna

Frequency	850/900/1800/1900 MHz
Impedance	50 $\Omega$
Maximum power output	2W
Antenna connector type	SMA (male)
Cable length	3-10 m or without cable

#### Power Supply

Adapter	230 V $\pm$ 10%, 50/60 Hz / 12V DC
DC power supply	12 V DC / 1 A
Supply connector	DC jack, 2.1 mm
Lithium battery	CR2032

**VoIP**

Signalling	SIP
Count of channels	4
Codecs	G.711 PCM at 64 kbps
	G.726 and G.727 E-ADPCM at 16 to 40 kbps
	G.723.1 (optional) MP-MLQ/ACELP at 6.3/5.3 kbps
Echo cancellation	G.168-2000; max. echo length 25ms (15 ms for G.729A)
VAD/CNG	G.729B or G.729A coders
(Silence Suppression)	G.723.1A for G.723.1 coders
PCM Companding	A-law/u-law (selectable)

**Interface**

RS232	
Connector	D-Sub 9 pins - slots
Interface transmission rate	57,600 bit / s
USB	
Connector	B type
	USB 1.1
Ethernet	
	RJ45
	10BaseT

<b>Remote supervision</b>	Ethernet (telnet)
---------------------------	-------------------

**Others**

Dimensions (w/o connectors)	250 x 150 x 50 mm
Operating temperature	0°C to 40°C
Relative humidity	5 to 95% (non condensing)